

Almstrup Bæk

Regulativrevision

Lodret akse : Kote i m DVR90, skala 1:50

Vandret akse : Afstand i m, skala 1:50

- Tidligere regulativ
- Regulativ
- Opmålt profil



Bilag 4.1

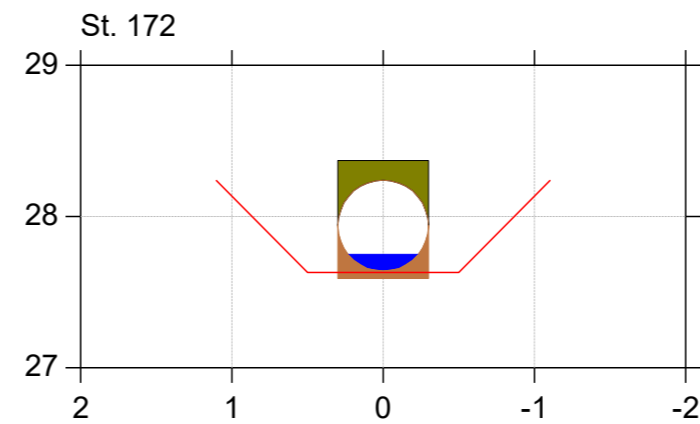
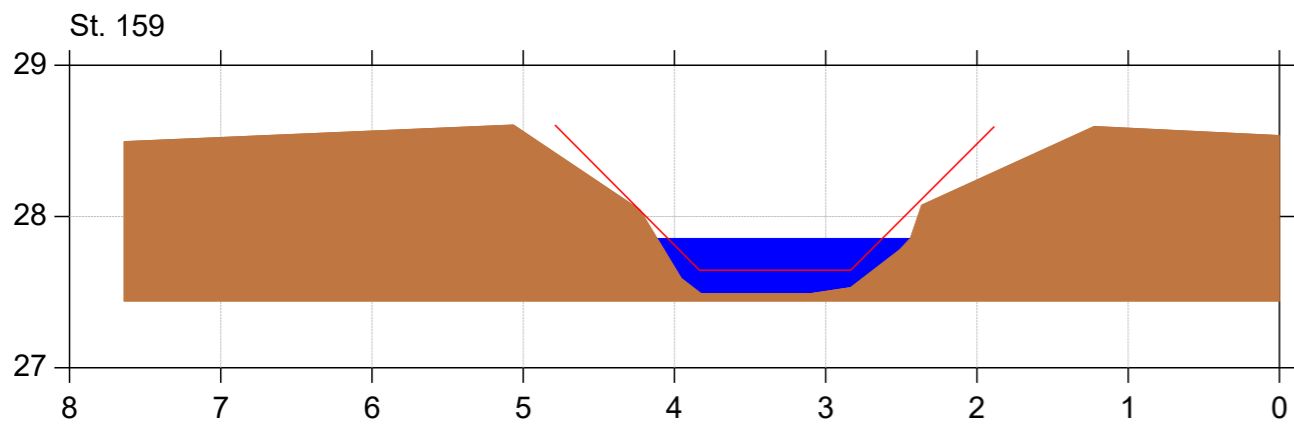
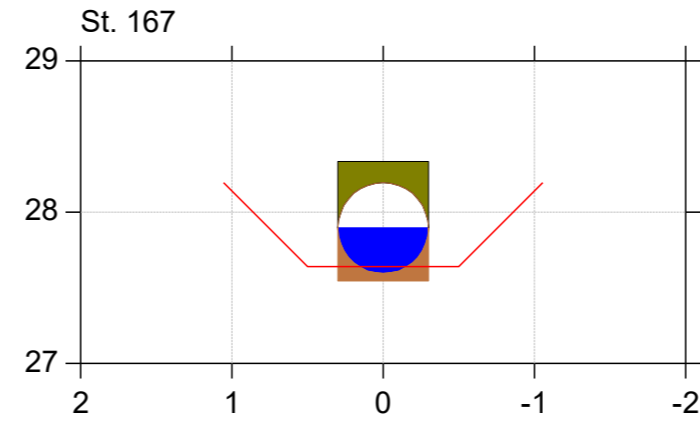
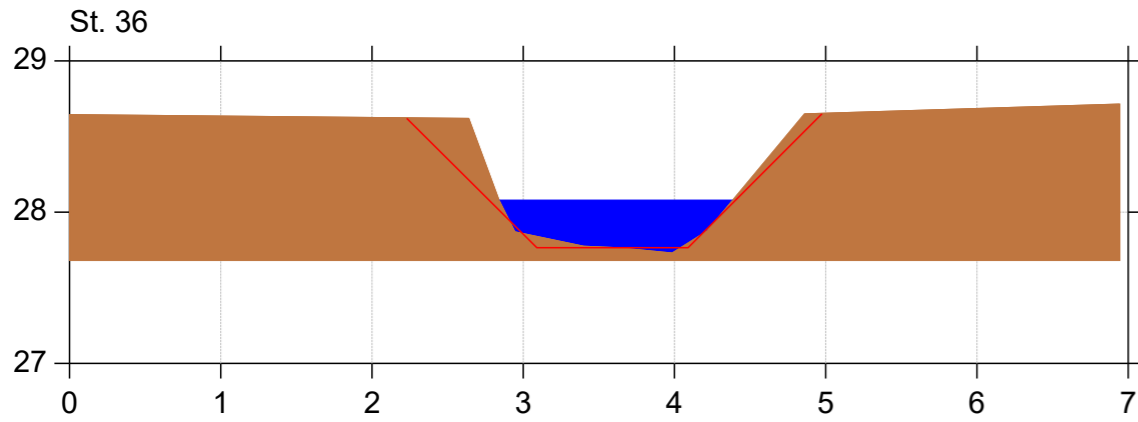

Almstrup Bæk

Regulativrevision

Lodret akse : Kote i m DVR90, skala 1:50

Vandret akse : Afstand i m, skala 1:50

- Tidligere regulativ
- Regulativ
- Opmålt profil



Bilag 4.1

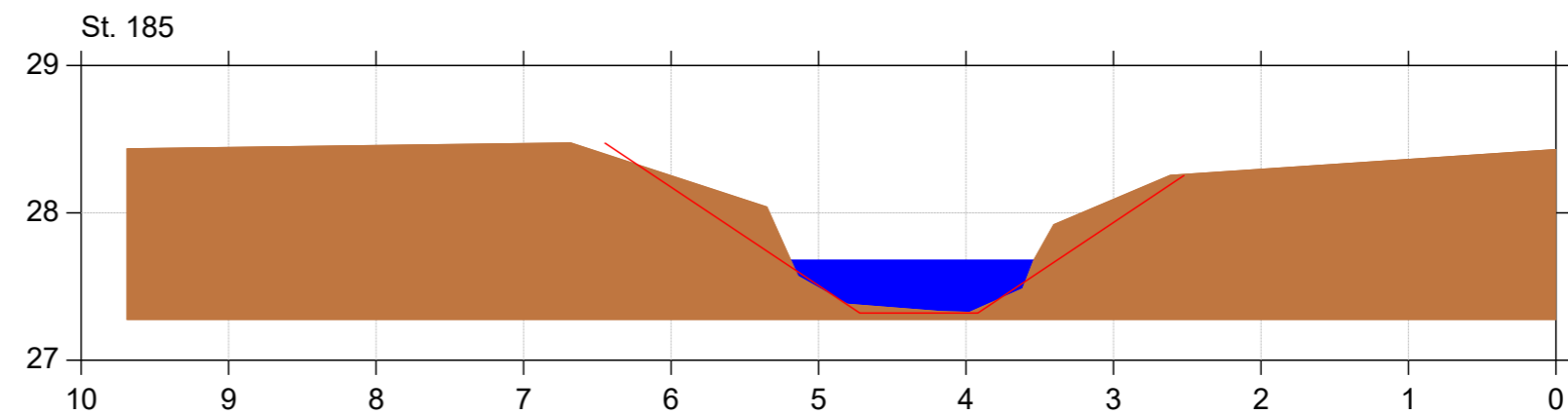
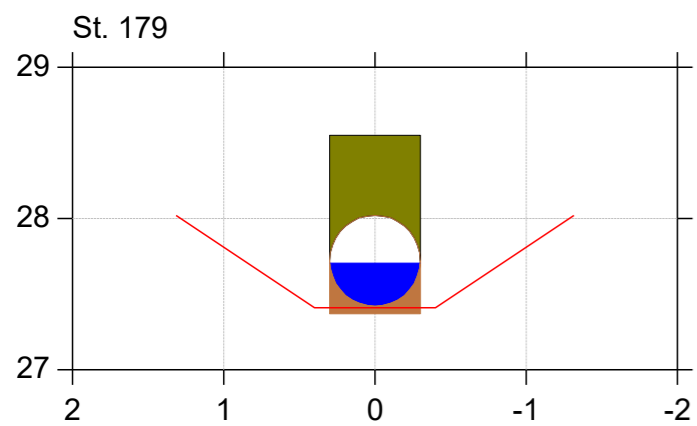
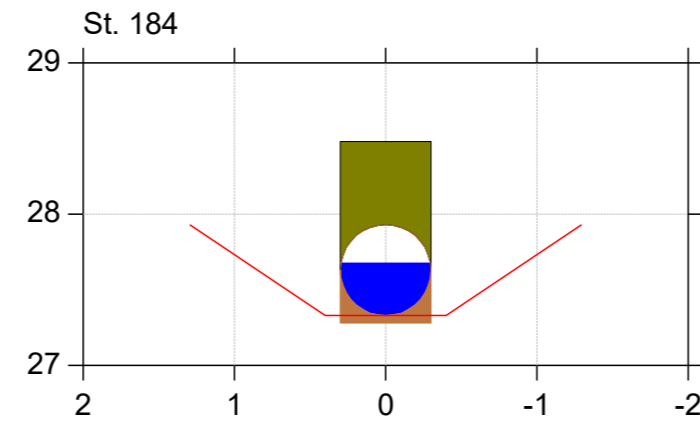
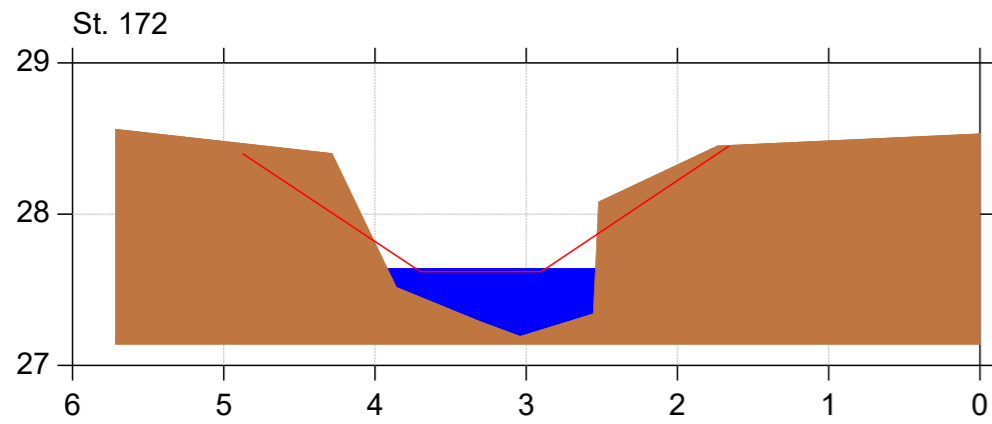

Almstrup Bæk

Regulativrevision

Lodret akse : Kote i m DVR90, skala 1:50

Vandret akse : Afstand i m, skala 1:50

- Tidligere regulativ
- Regulativ
- Opmålt profil



Bilag 4.1

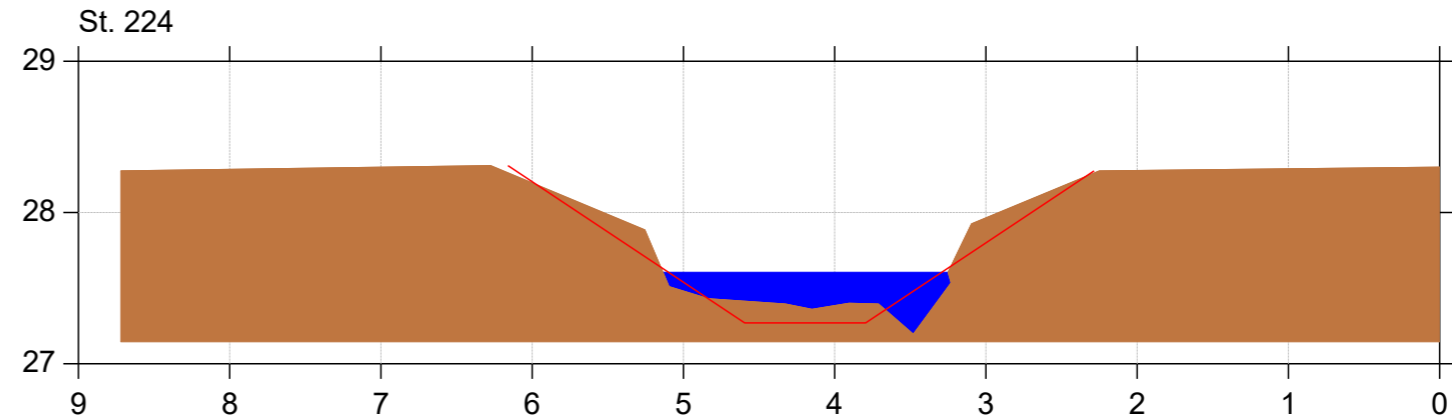
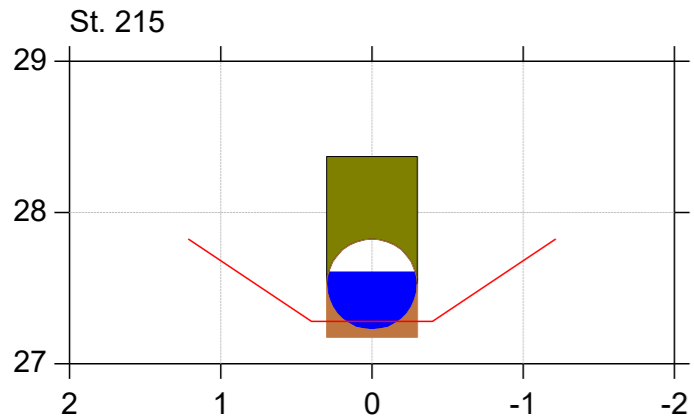
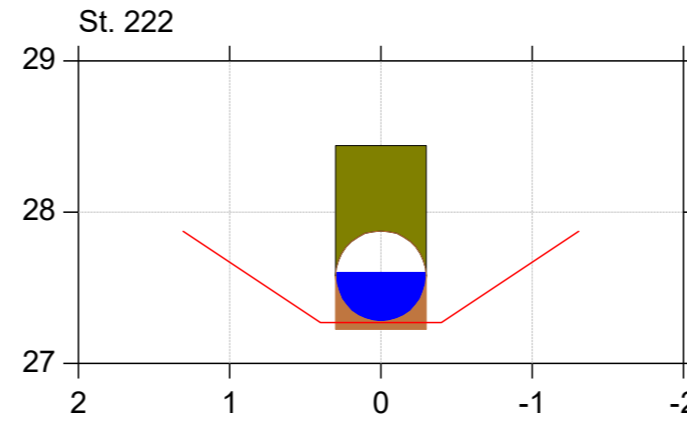
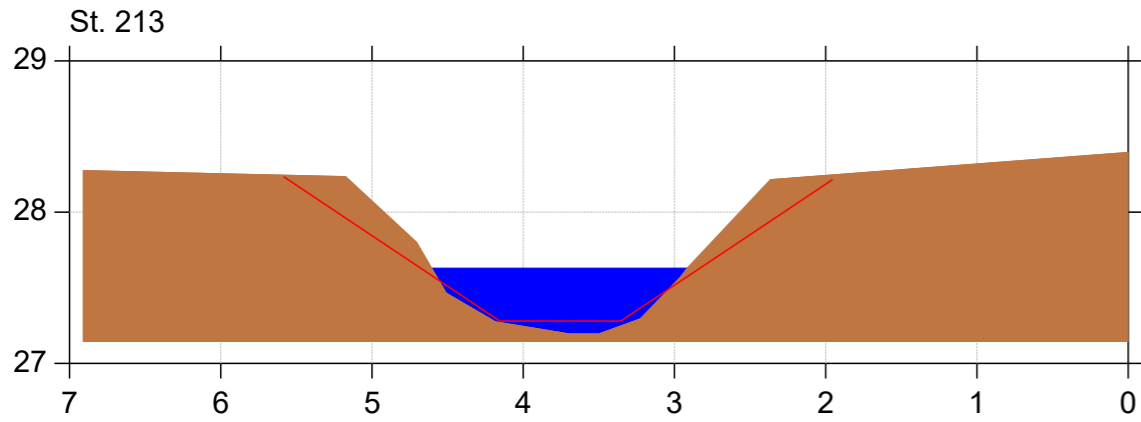

Almstrup Bæk

Regulativrevision

Lodret akse : Kote i m DVR90, skala 1:50

Vandret akse : Afstand i m, skala 1:50

- Tidligere regulativ
- Regulativ
- Opmålt profil



Bilag 4.1

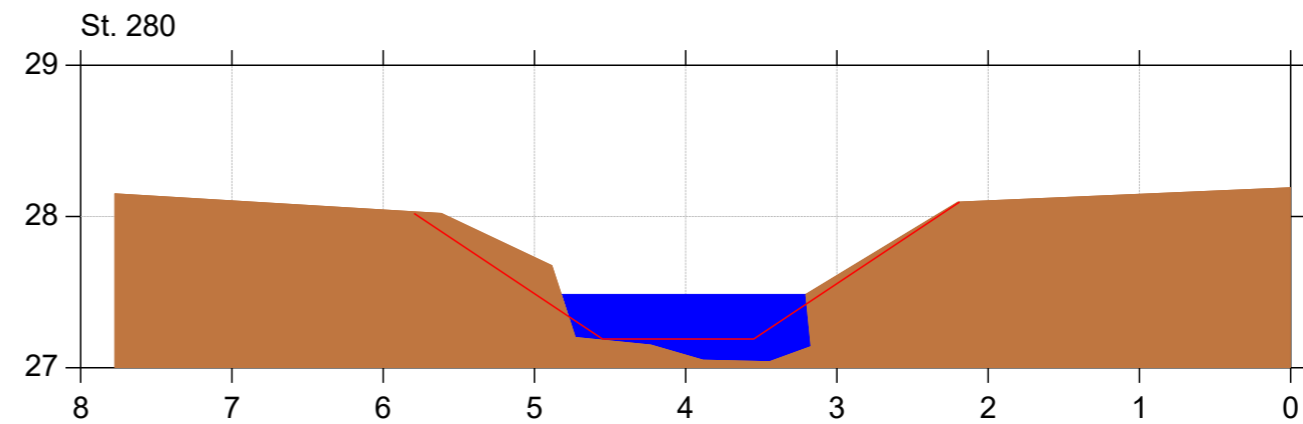
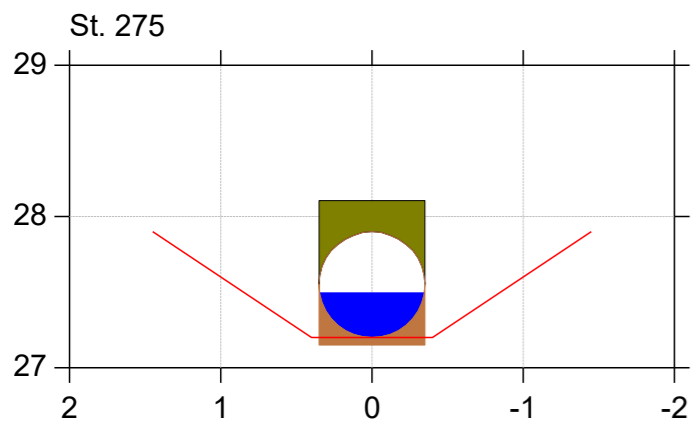
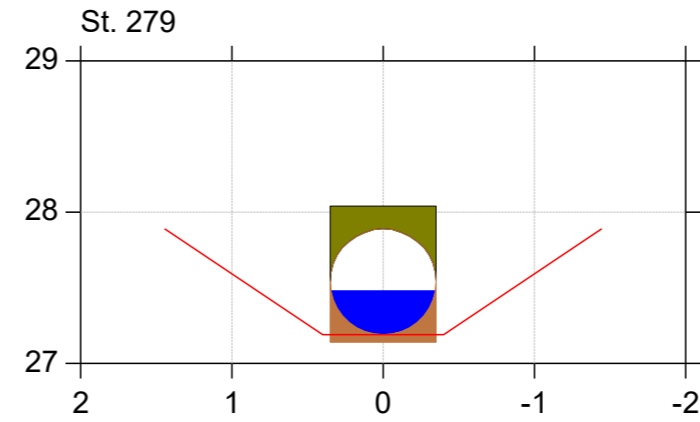
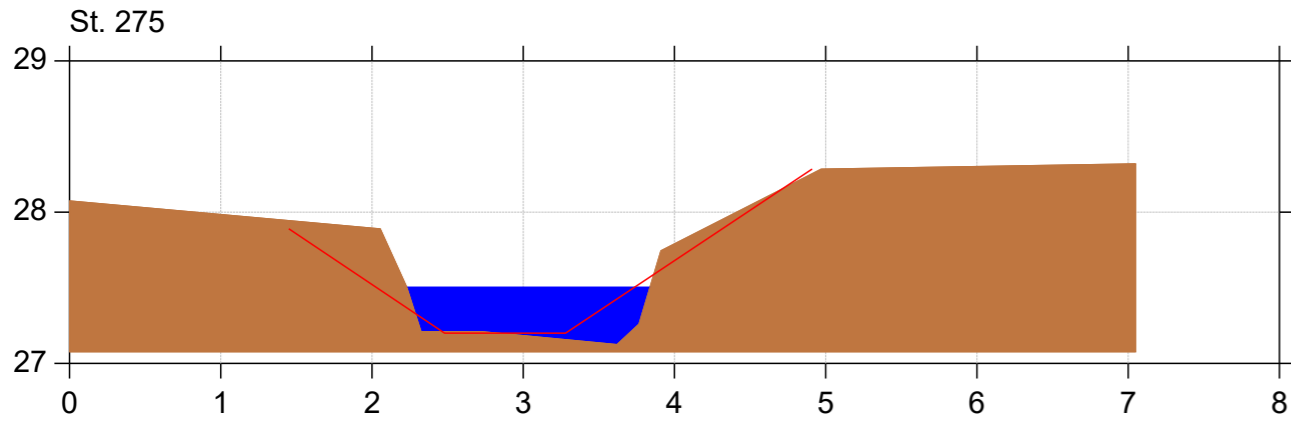

Almstrup Bæk

Regulativrevision

Lodret akse : Kote i m DVR90, skala 1:50

Vandret akse : Afstand i m, skala 1:50

- Tidligere regulativ
- Regulativ
- Opmålt profil



Bilag 4.1

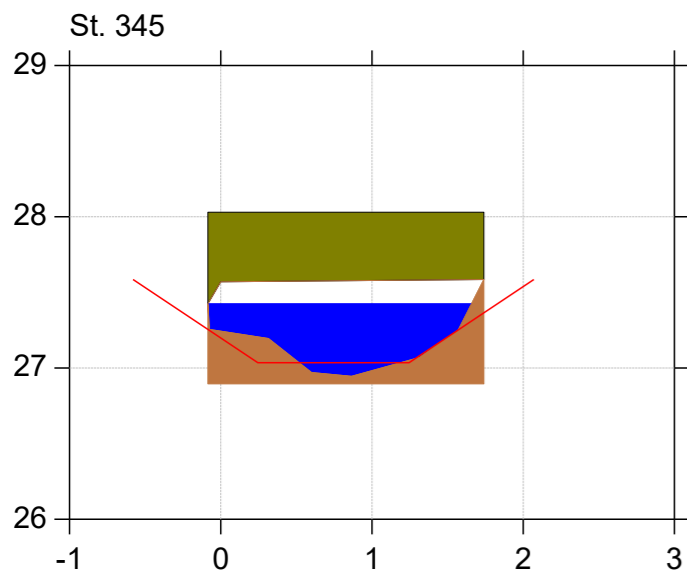
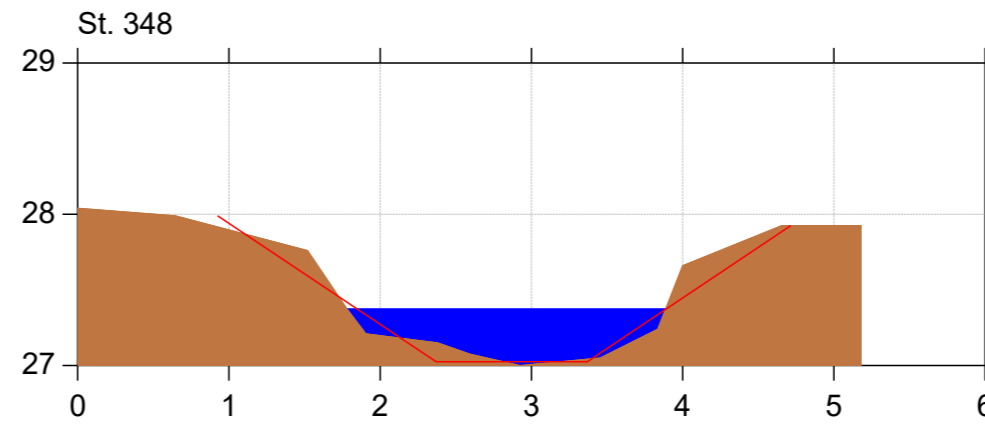
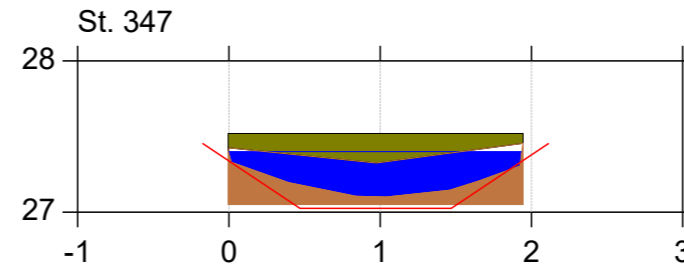
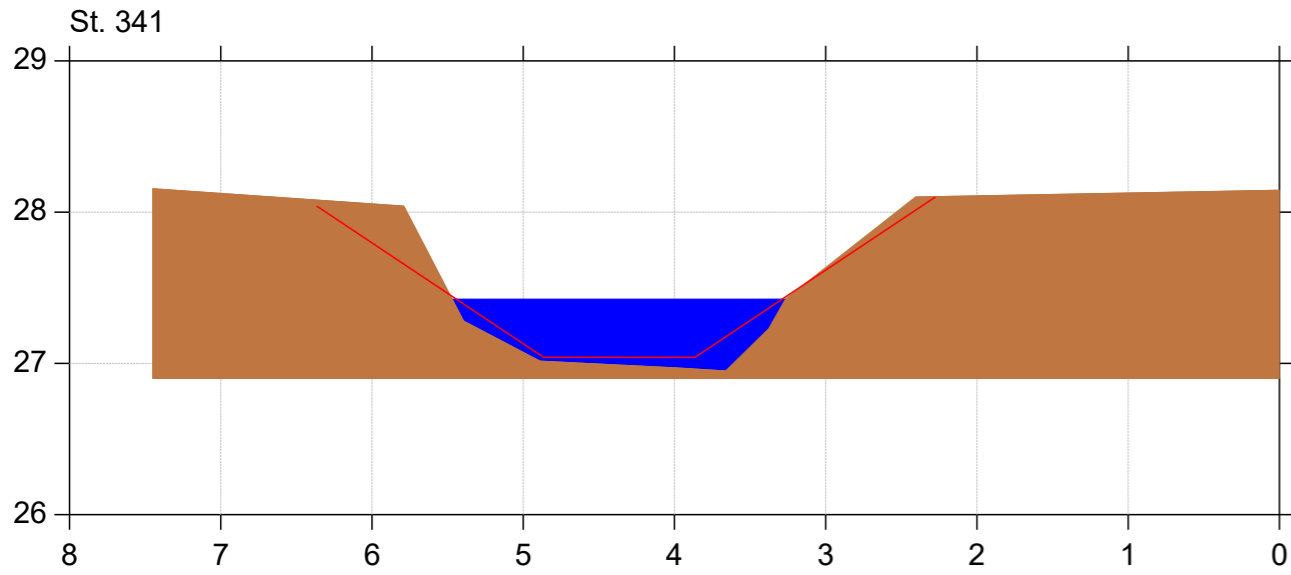

Almstrup Bæk

Regulativrevision

Lodret akse : Kote i m DVR90, skala 1:50

Vandret akse : Afstand i m, skala 1:50

- Tidligere regulativ
- Regulativ
- Opmålt profil



Bilag 4.1

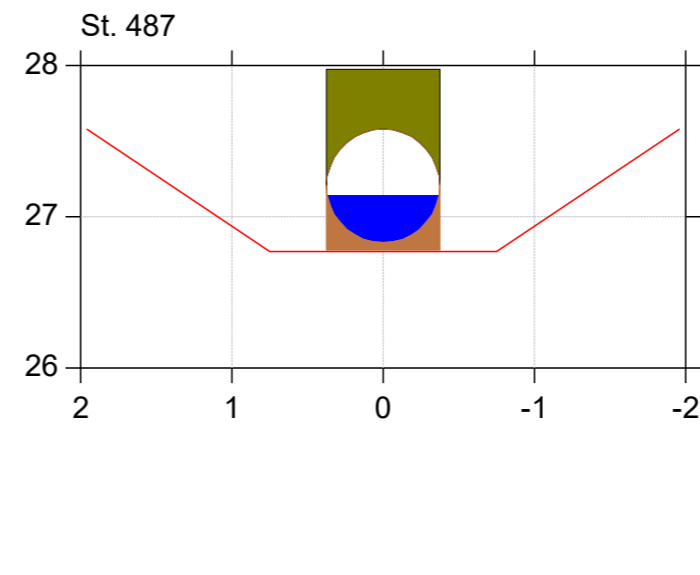
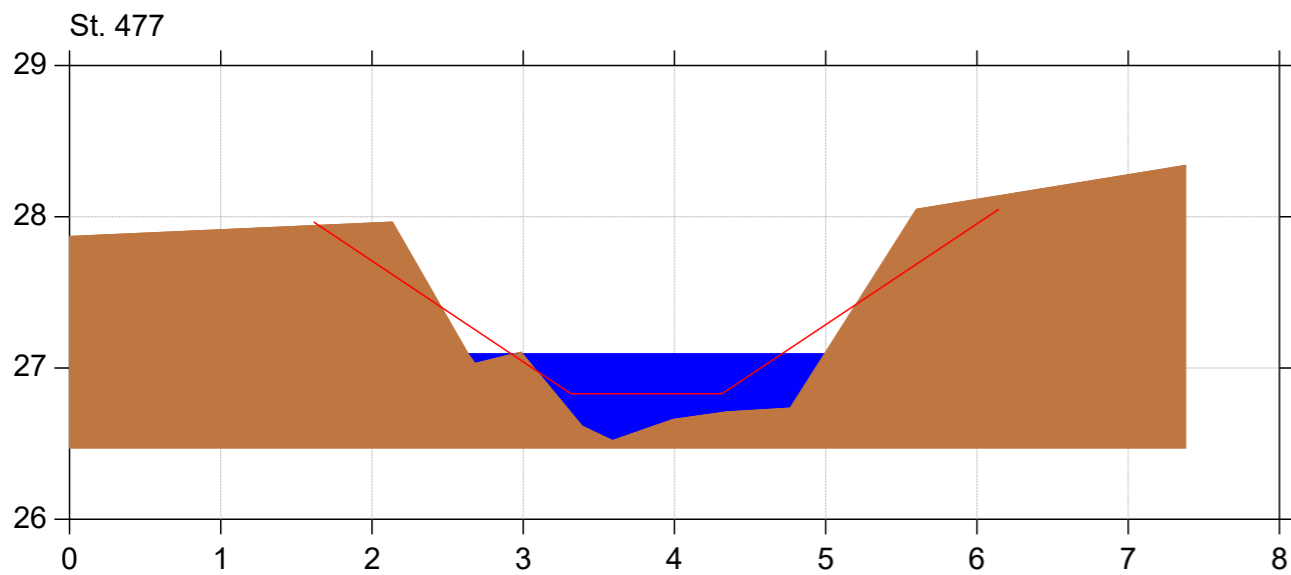
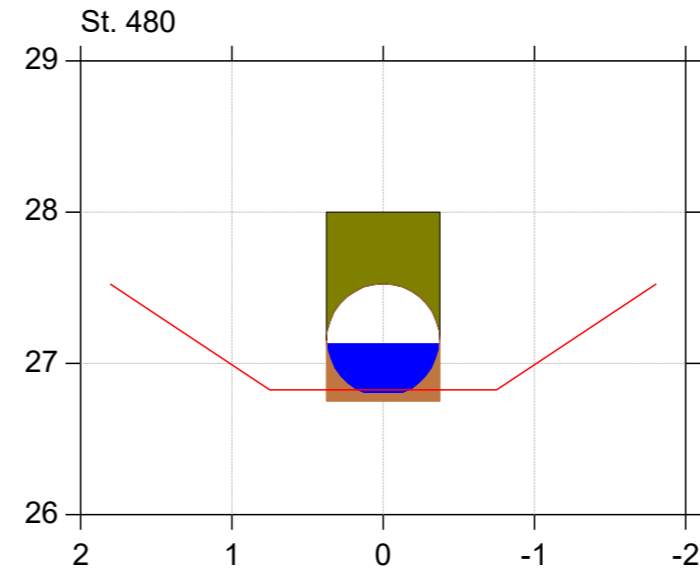
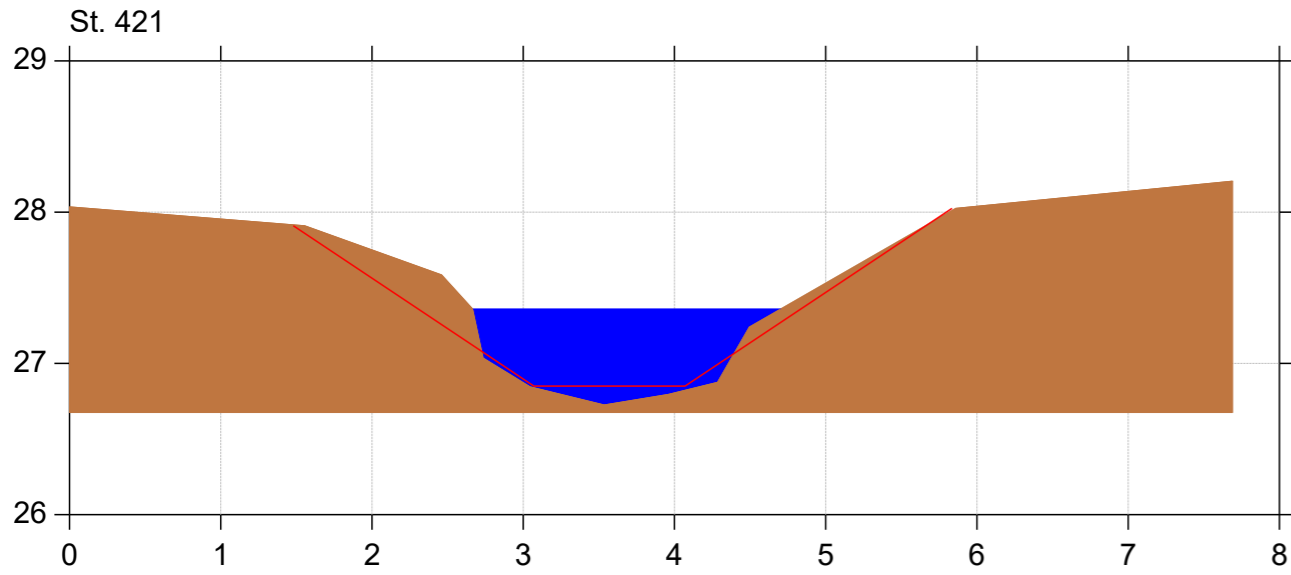

Almstrup Bæk

Regulativrevision

Lodret akse : Kote i m DVR90, skala 1:50

Vandret akse : Afstand i m, skala 1:50

- Tidligere regulativ
- Regulativ
- Opmålt profil



Bilag 4.1

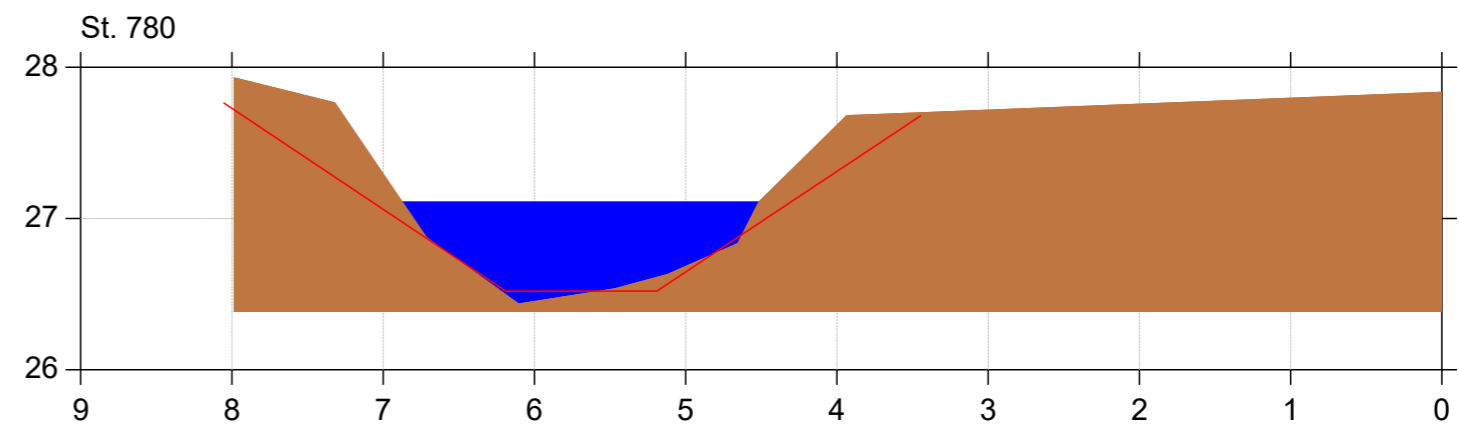
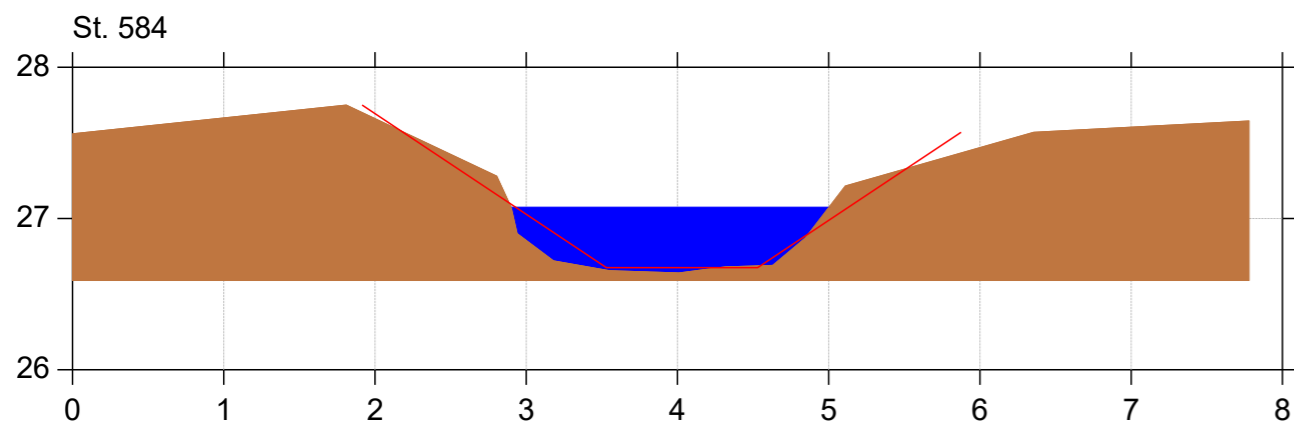
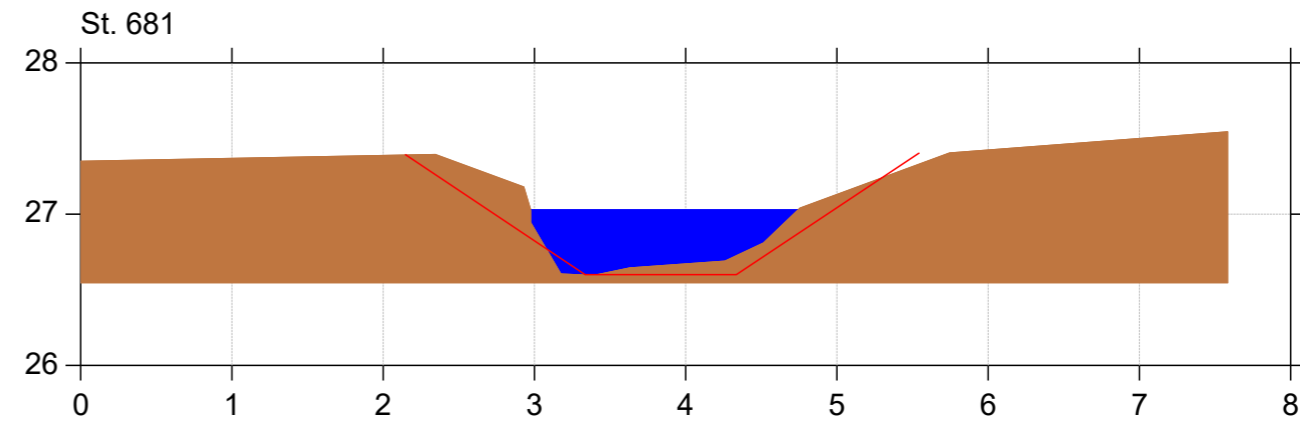
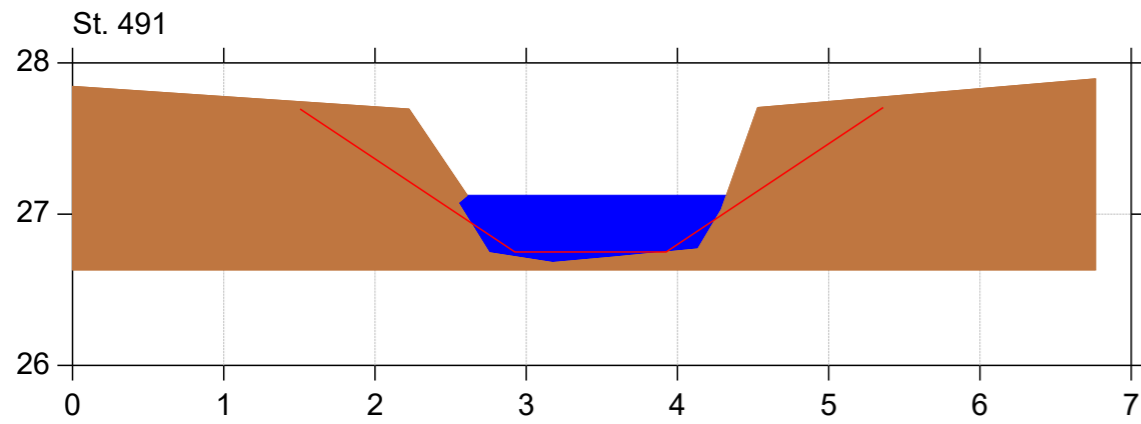

Almstrup Bæk

Regulativrevision

Lodret akse : Kote i m DVR90, skala 1:50

Vandret akse : Afstand i m, skala 1:50

- Tidligere regulativ
- Regulativ
- Opmålt profil



Bilag 4.1

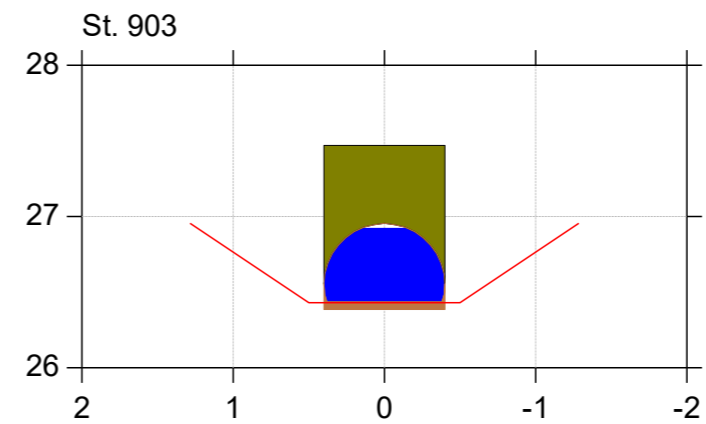
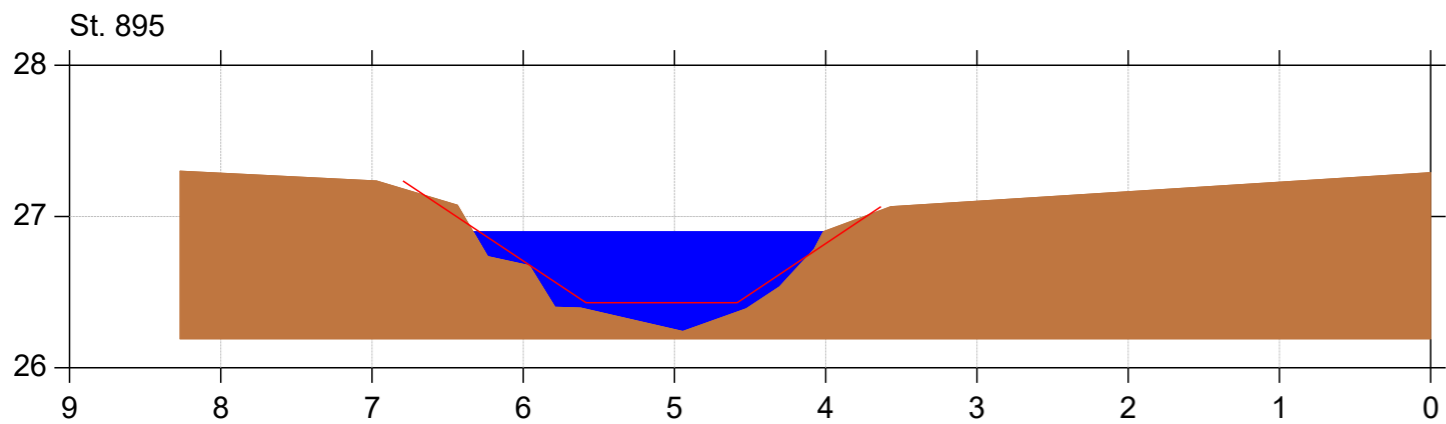
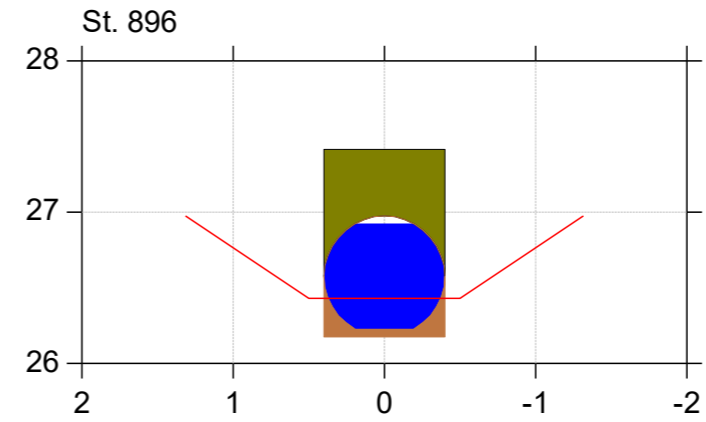
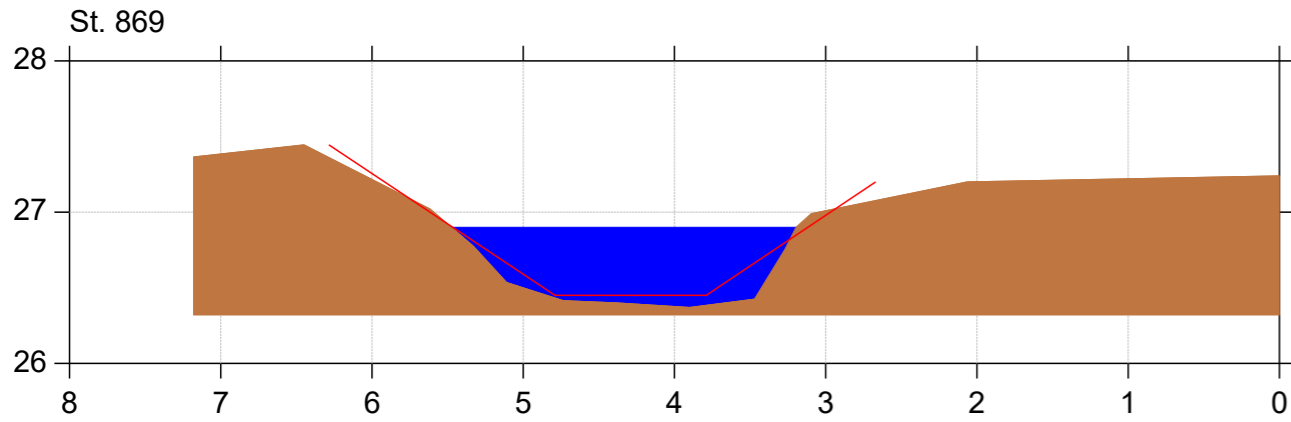

Almstrup Bæk

Regulativrevision

Lodret akse : Kote i m DVR90, skala 1:50

Vandret akse : Afstand i m, skala 1:50

- Tidligere regulativ
- Regulativ
- Opmålt profil



Bilag 4.1

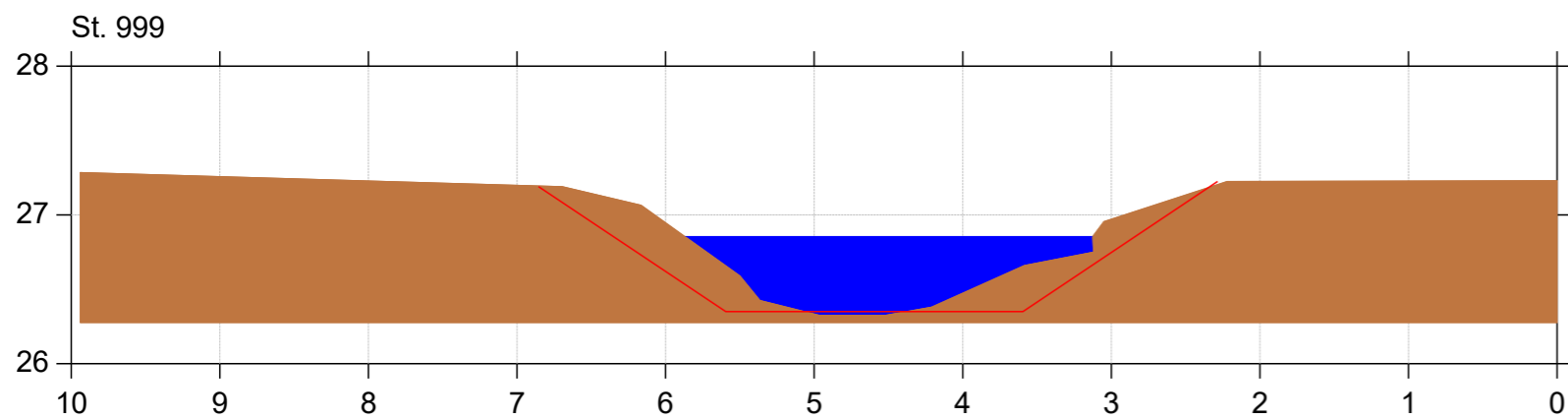
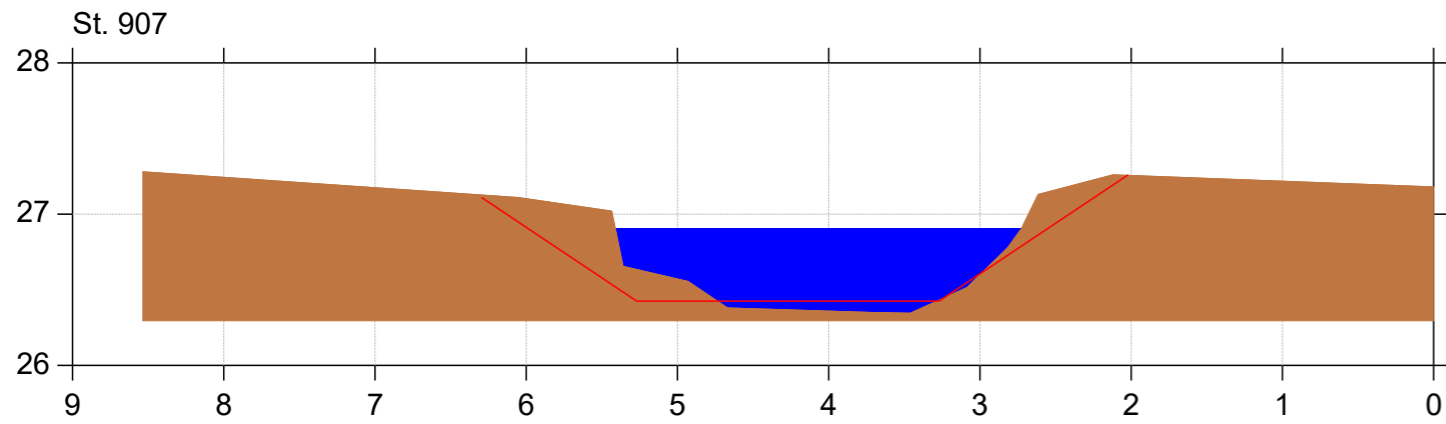

Almstrup Bæk

Regulativrevision

Lodret akse : Kote i m DVR90, skala 1:50

Vandret akse : Afstand i m, skala 1:50

- Tidligere regulativ
- Regulativ
- Opmålt profil



Bilag 4.1

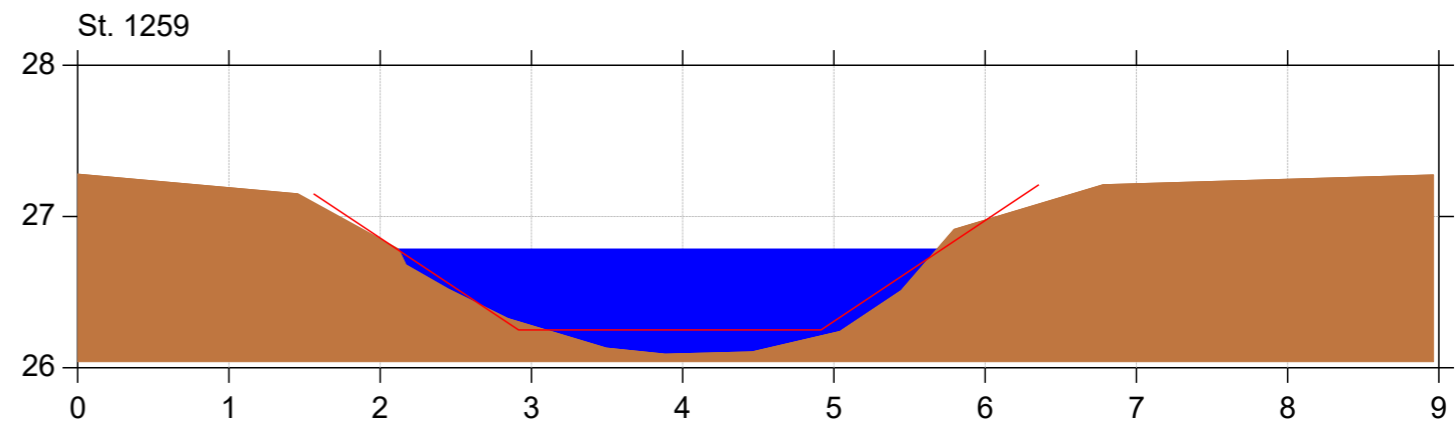
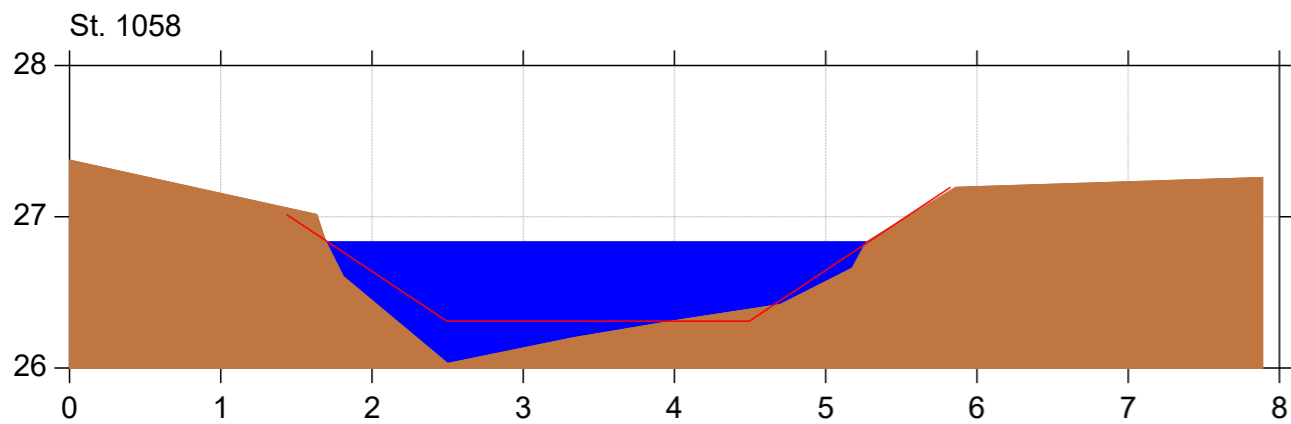
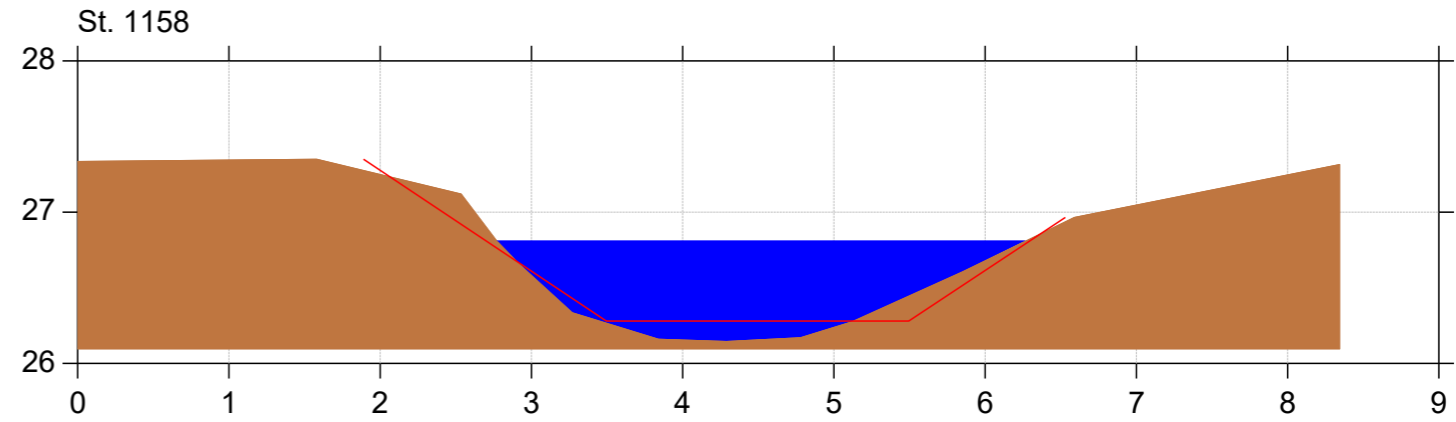
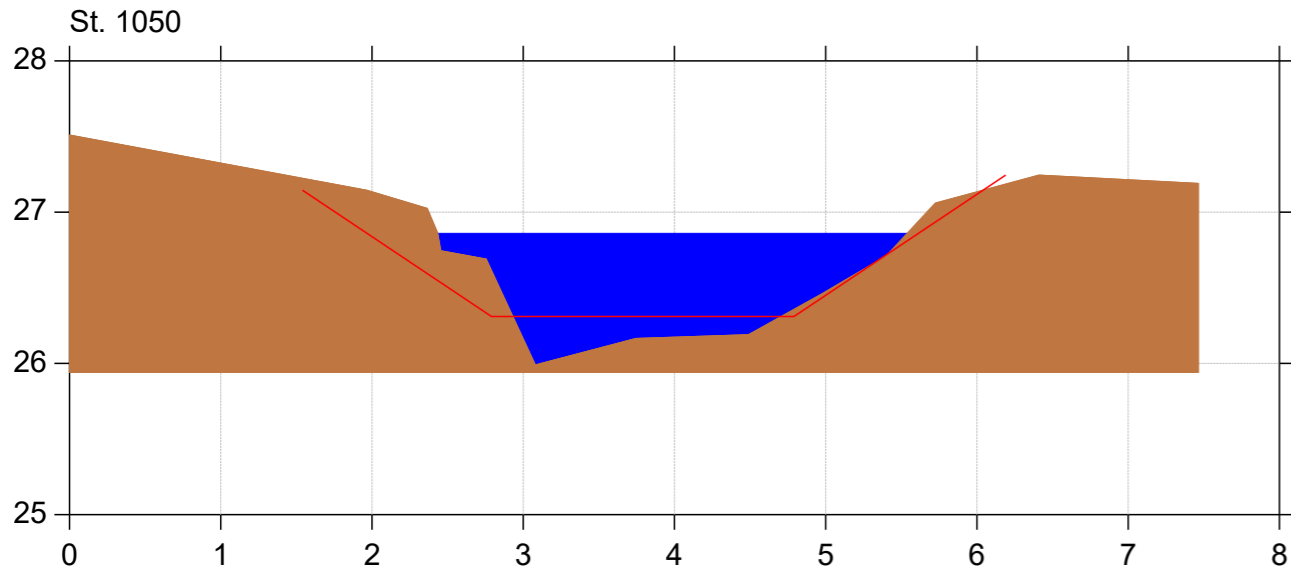

Almstrup Bæk

Regulativrevision

Lodret akse : Kote i m DVR90, skala 1:50

Vandret akse : Afstand i m, skala 1:50

- Tidligere regulativ
- Regulativ
- Opmålt profil



Bilag 4.1

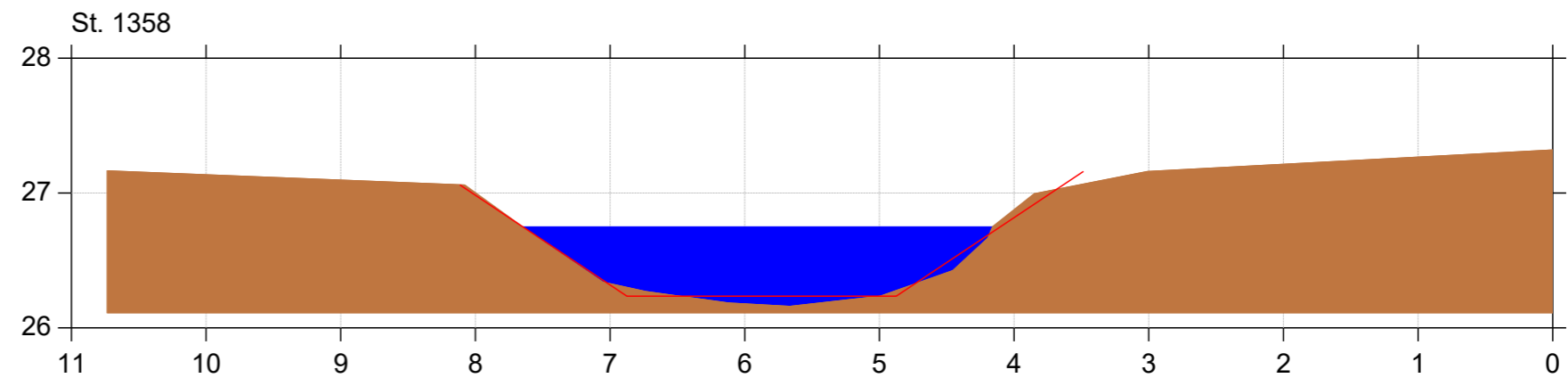
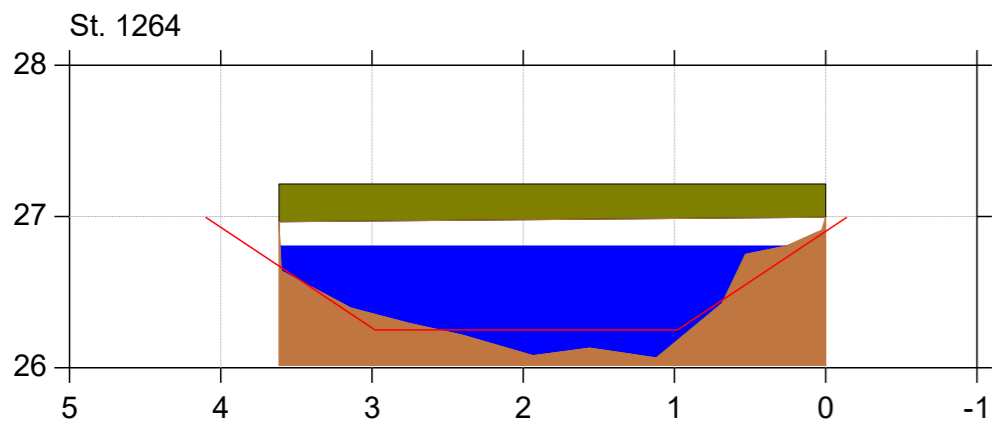
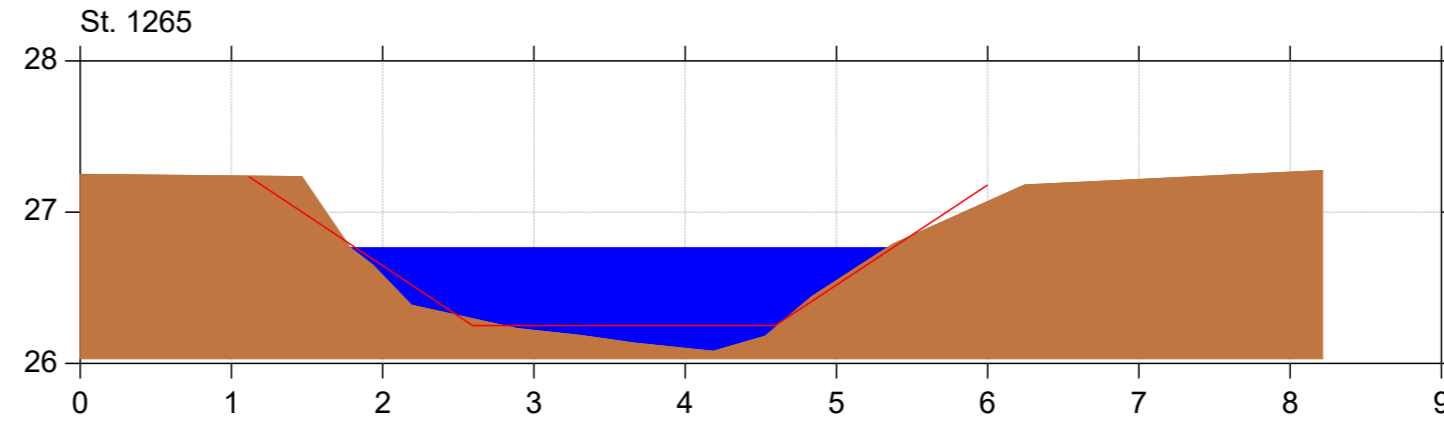
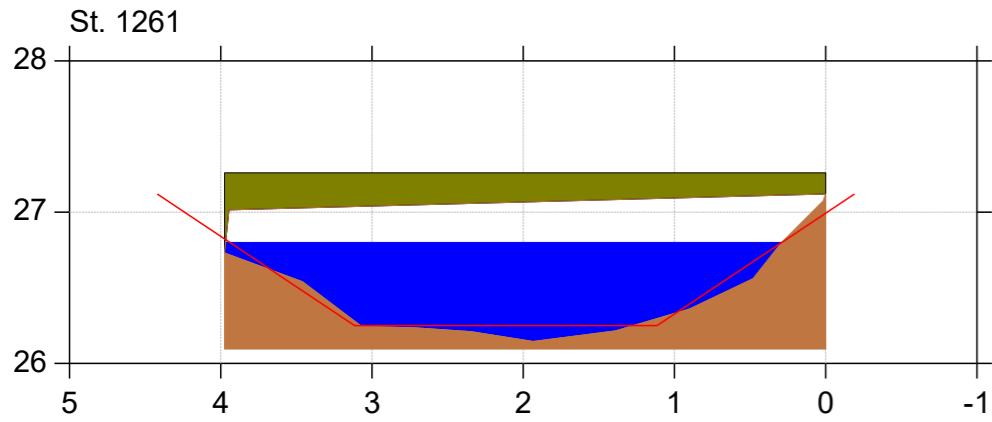

Almstrup Bæk

Regulativrevision

Lodret akse : Kote i m DVR90, skala 1:50

Vandret akse : Afstand i m, skala 1:50

- Tidligere regulativ
- Regulativ
- Opmålt profil



Bilag 4.1

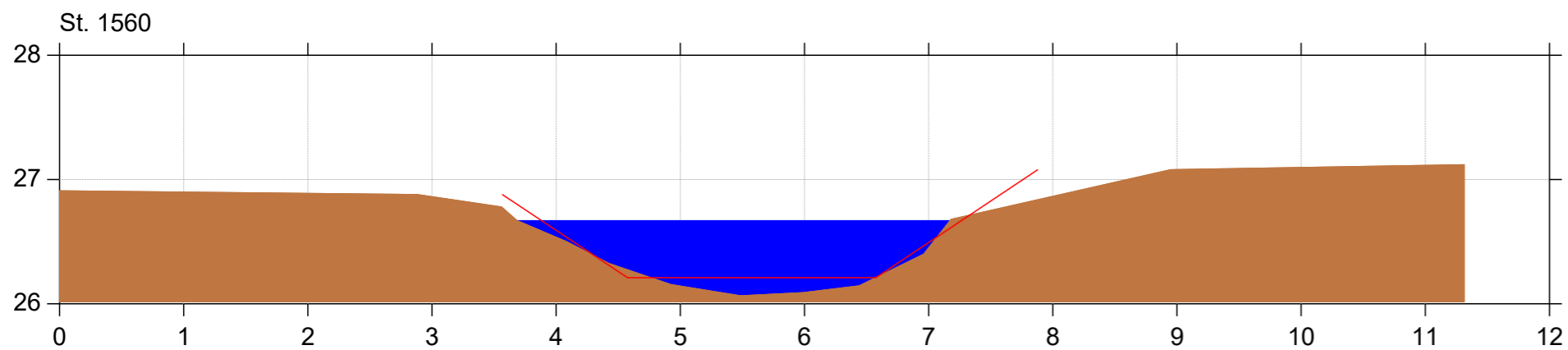
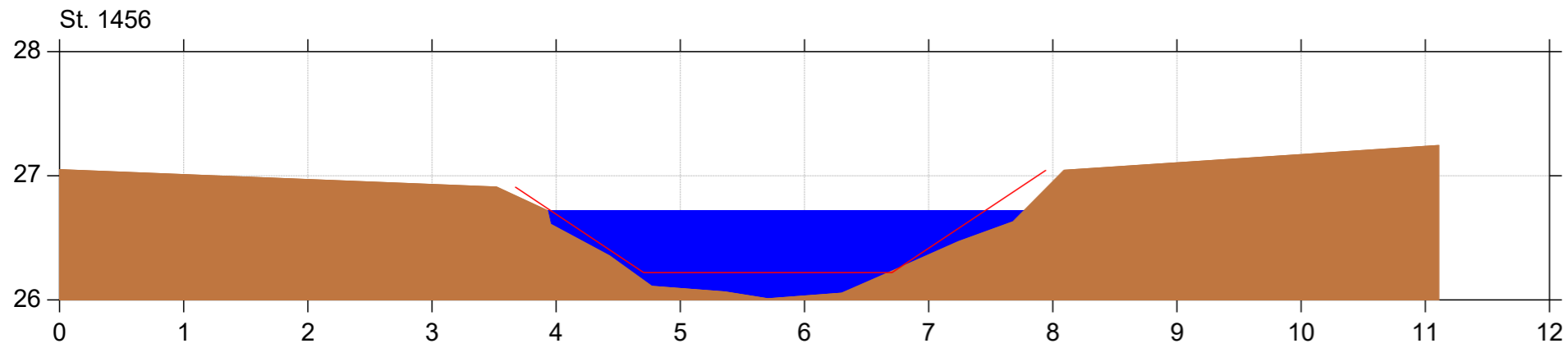

Almstrup Bæk

Regulativrevision

Lodret akse : Kote i m DVR90, skala 1:50

Vandret akse : Afstand i m, skala 1:50

- Tidligere regulativ
- Regulativ
- Opmålt profil



Bilag 4.1

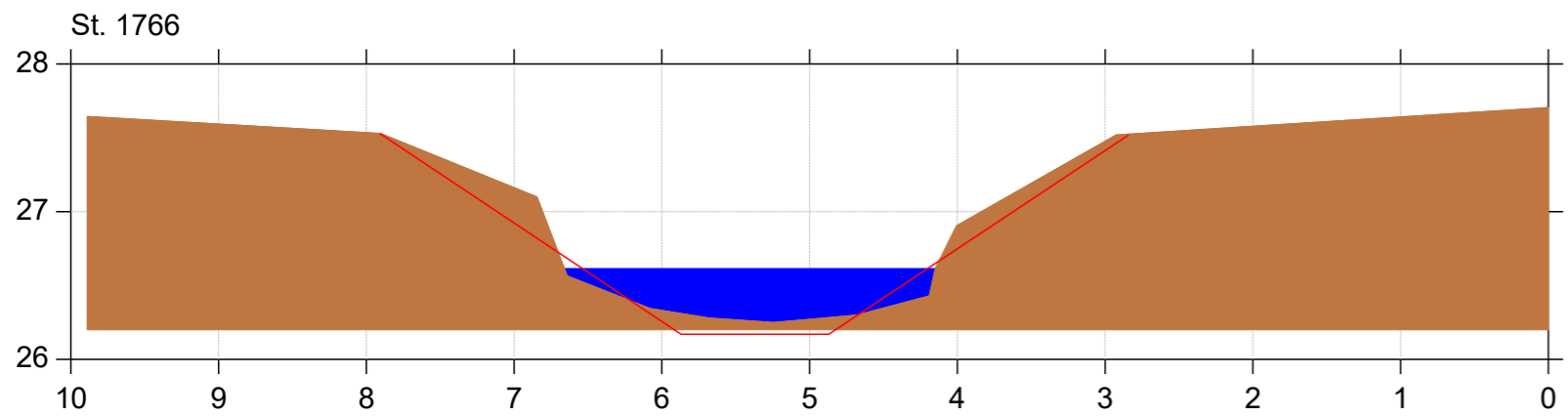
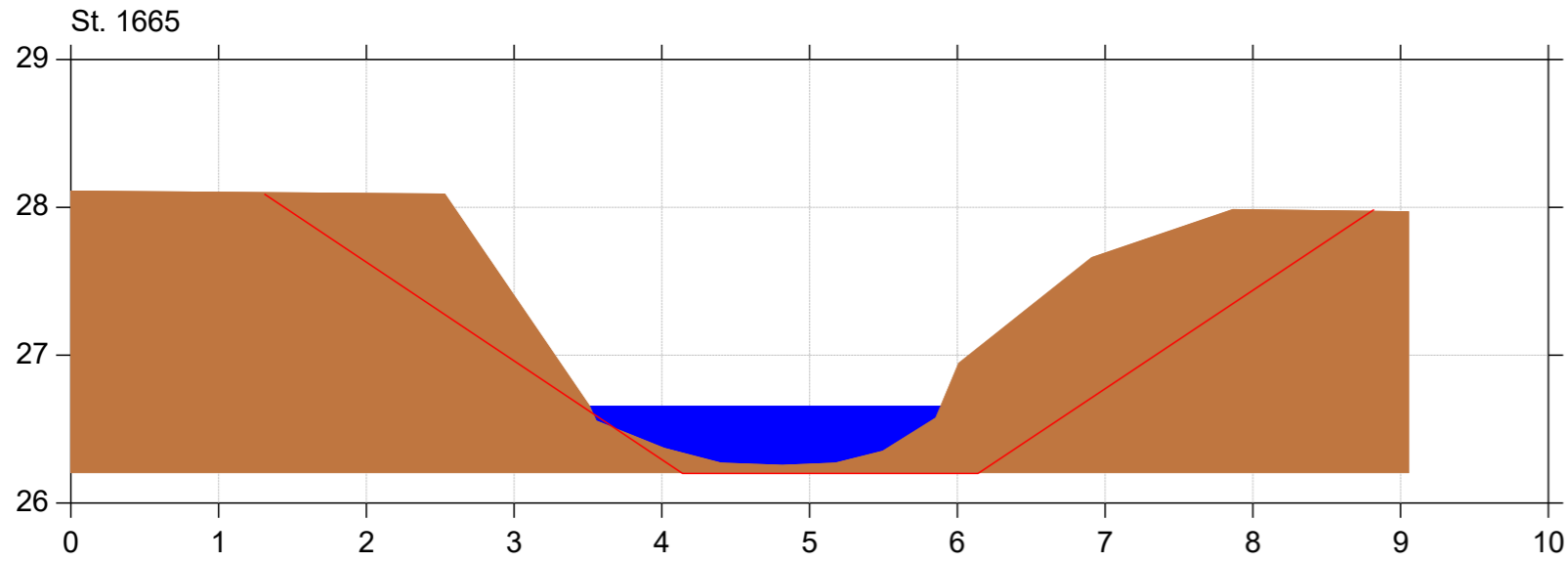

Almstrup Bæk

Regulativrevision

Lodret akse : Kote i m DVR90, skala 1:50

Vandret akse : Afstand i m, skala 1:50

- Tidligere regulativ
- Regulativ
- Opmålt profil



Bilag 4.1

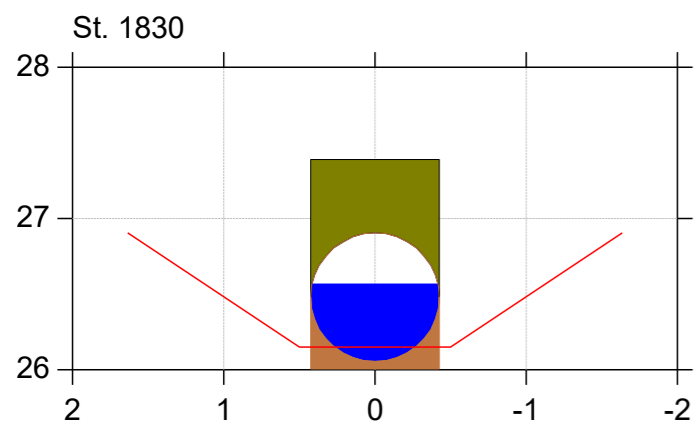
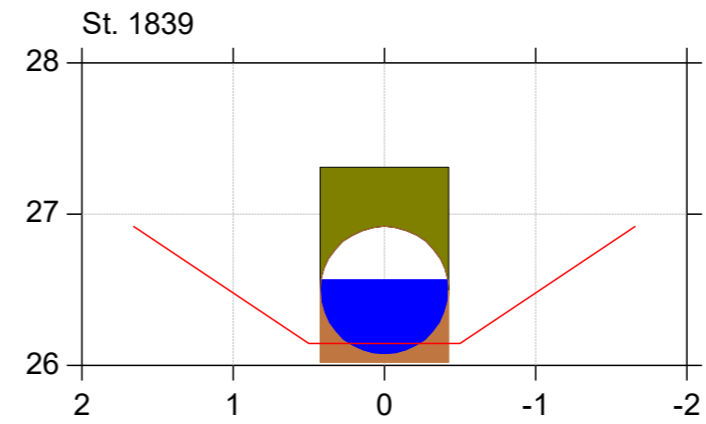
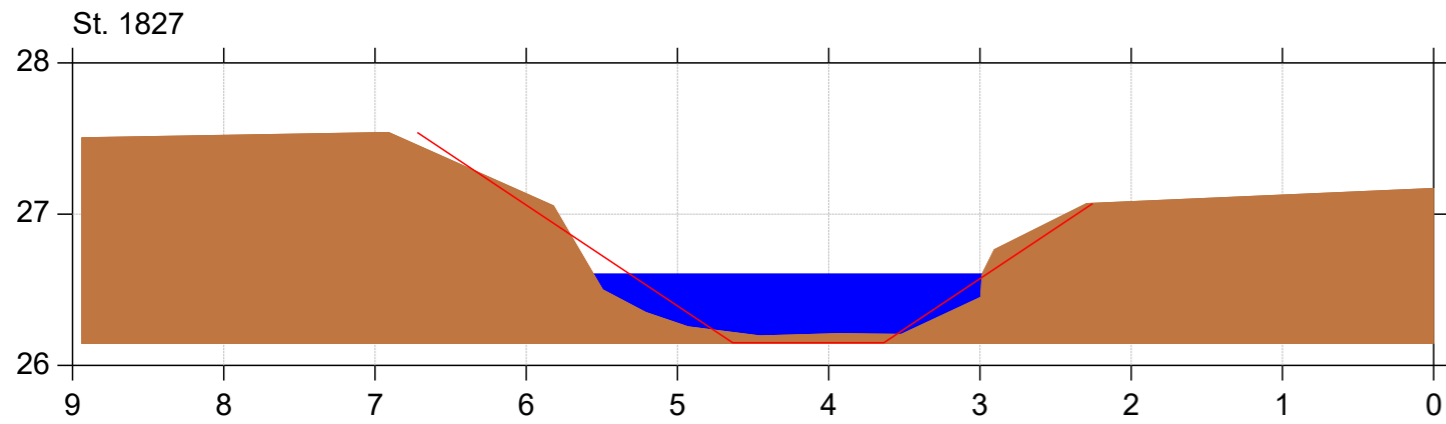

Almstrup Bæk

Regulativrevision

Lodret akse : Kote i m DVR90, skala 1:50

Vandret akse : Afstand i m, skala 1:50

- Tidligere regulativ
- Regulativ
- Opmålt profil



Bilag 4.1

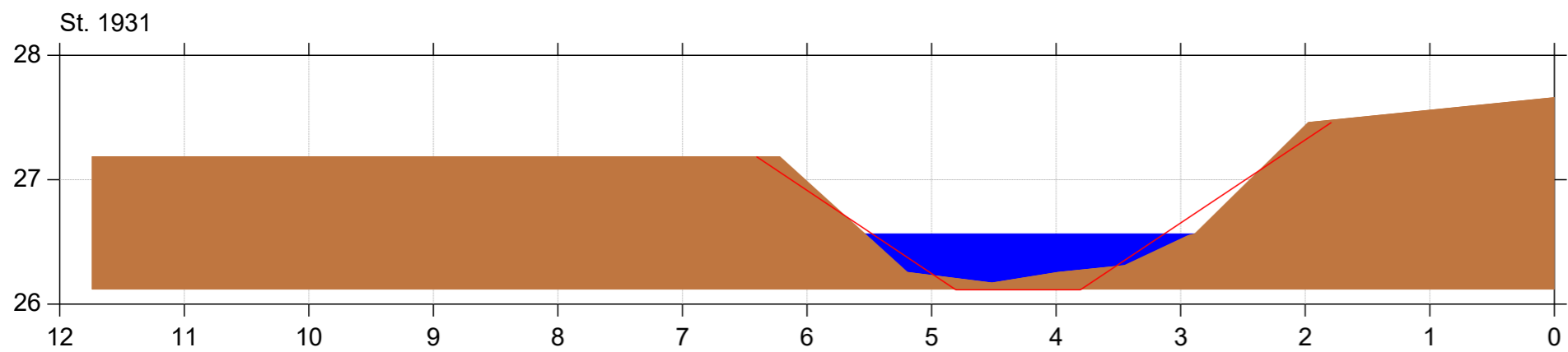
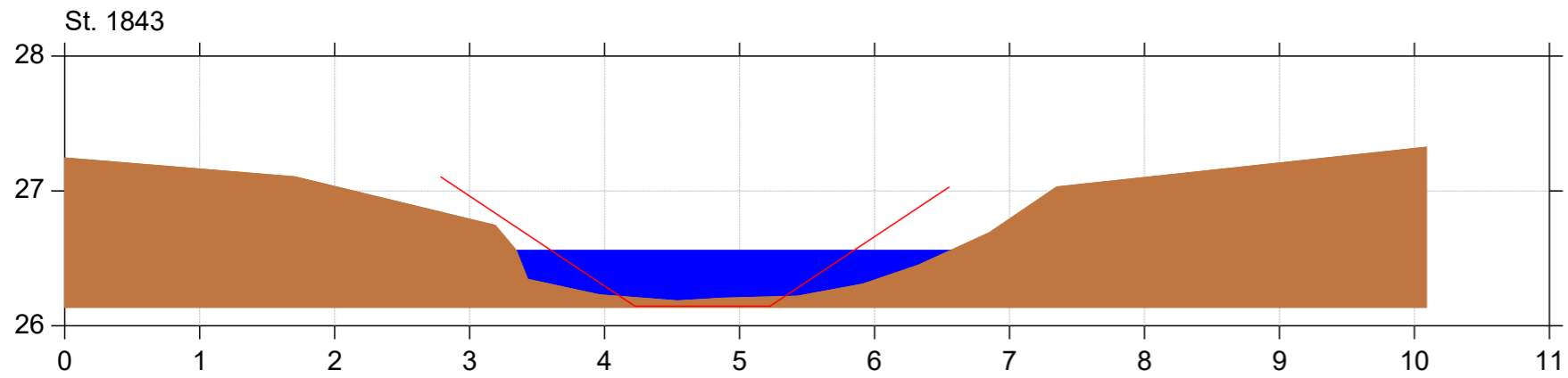

Almstrup Bæk

Regulativrevision

Lodret akse : Kote i m DVR90, skala 1:50

Vandret akse : Afstand i m, skala 1:50

- Tidligere regulativ
- Regulativ
- Opmålt profil



Bilag 4.1

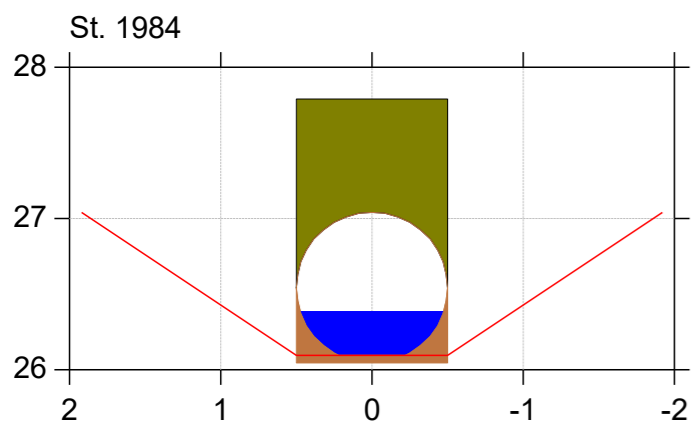
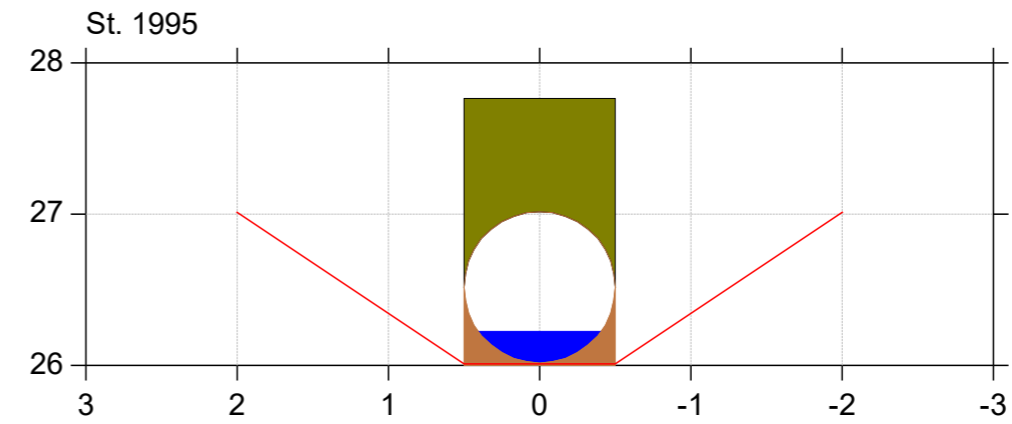
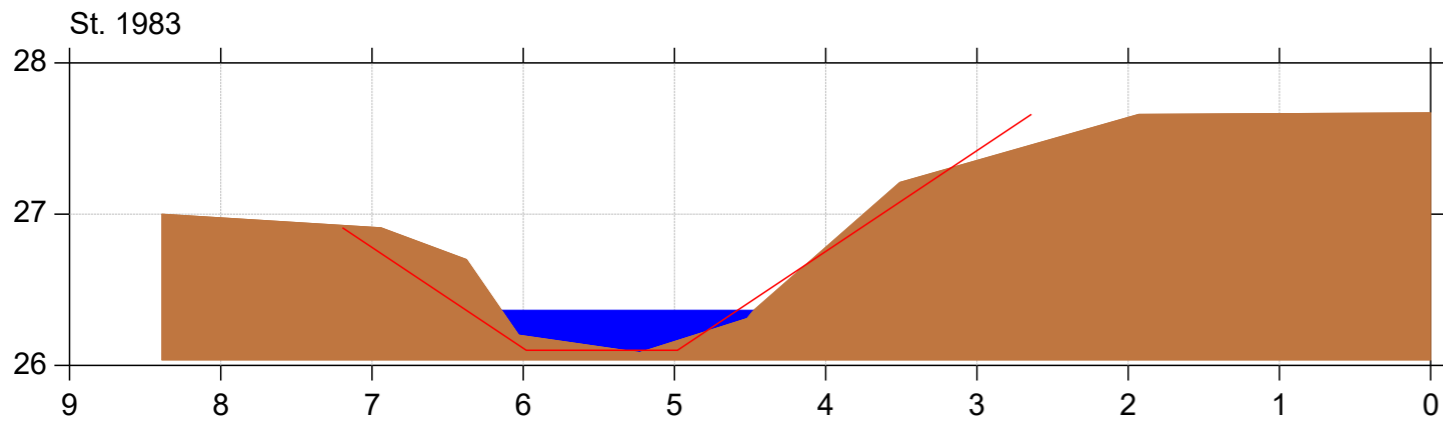

Almstrup Bæk

Regulativrevision

Lodret akse : Kote i m DVR90, skala 1:50

Vandret akse : Afstand i m, skala 1:50

- Tidligere regulativ
- Regulativ
- Opmålt profil



Bilag 4.1

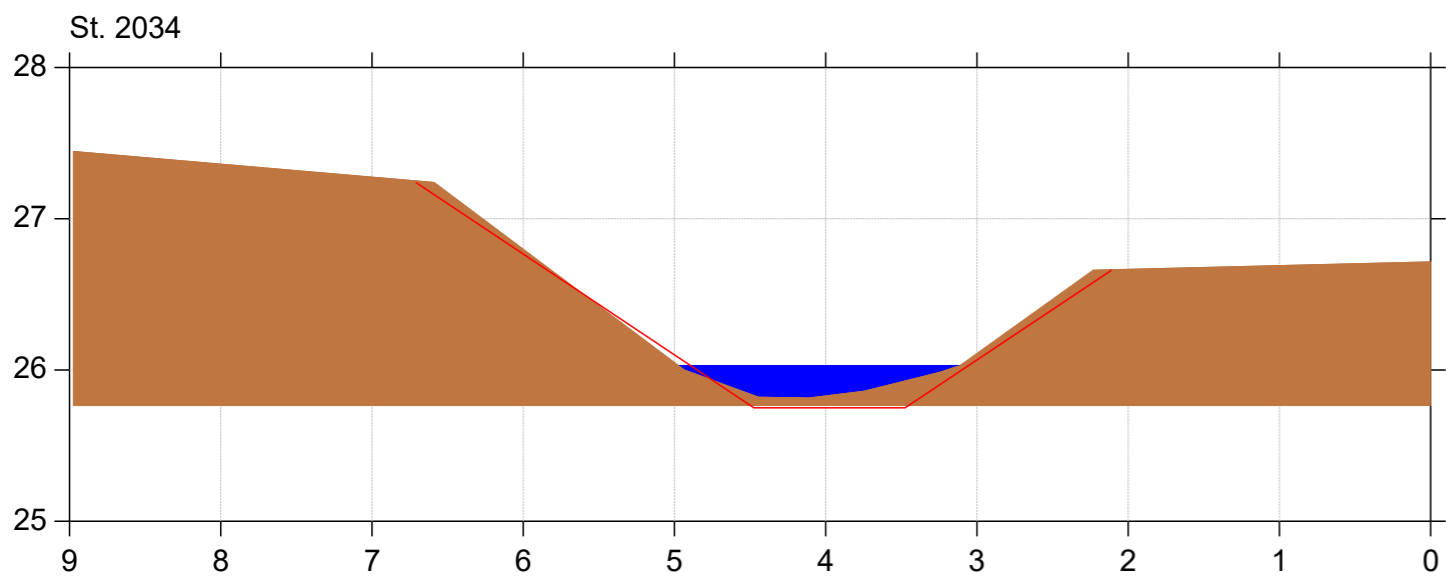
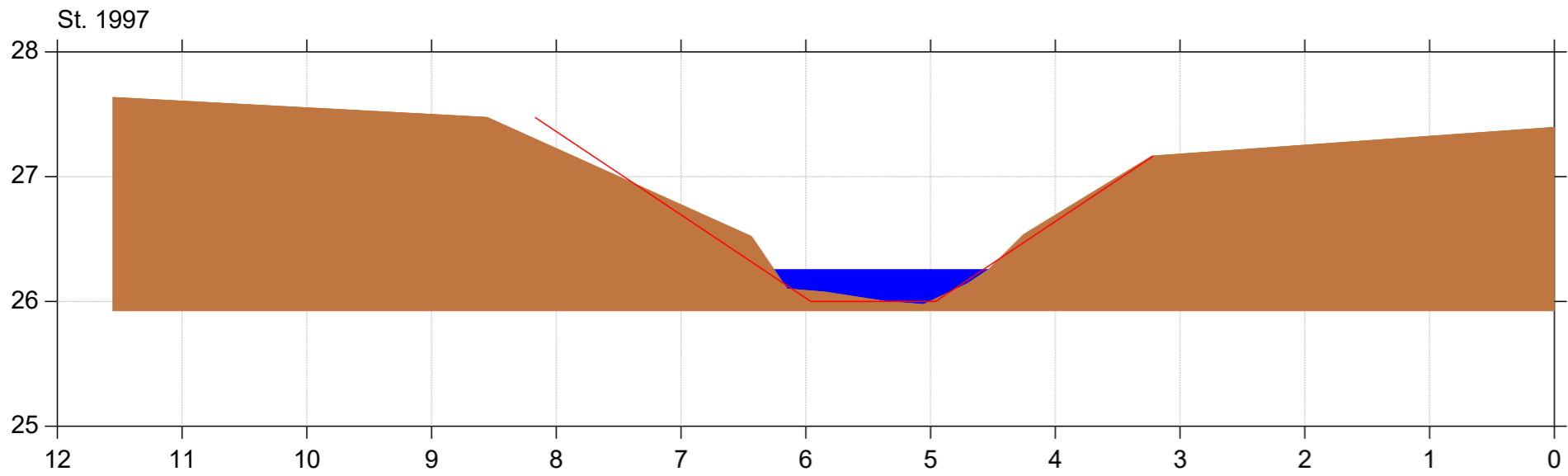

Almstrup Bæk

Regulativrevision

Lodret akse : Kote i m DVR90, skala 1:50

Vandret akse : Afstand i m, skala 1:50

- Tidligere regulativ
- Regulativ
- Opmålt profil



Bilag 4.1

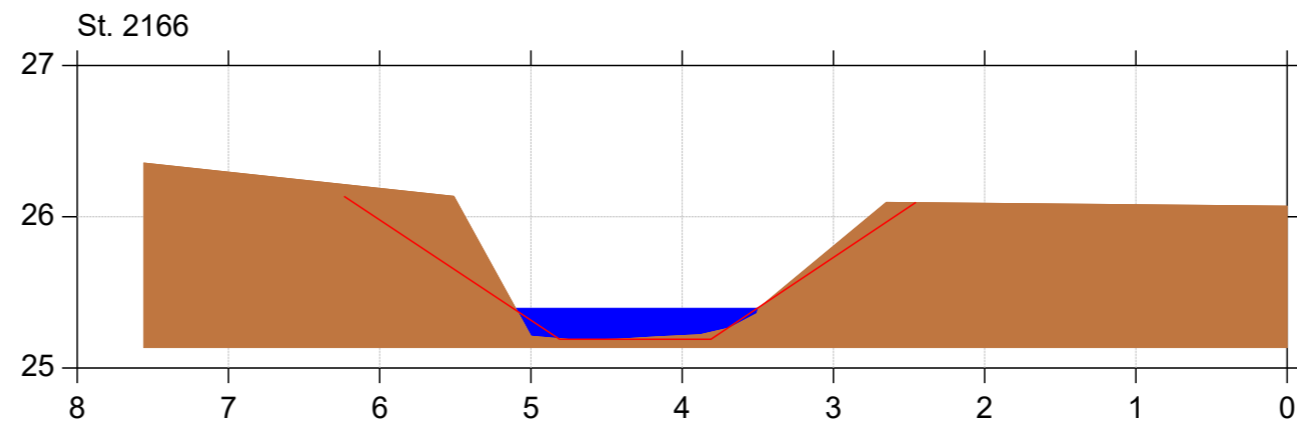
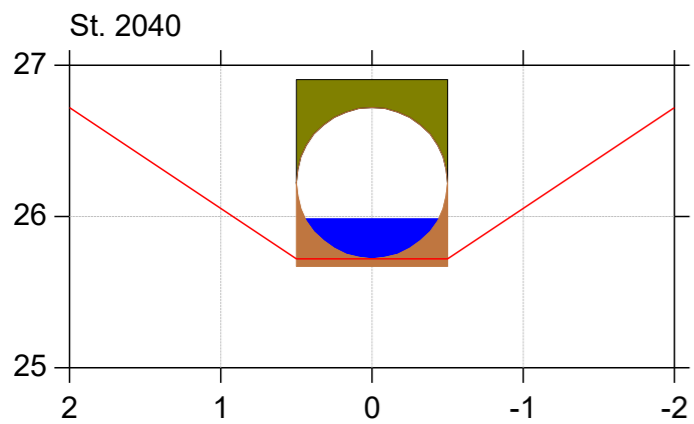
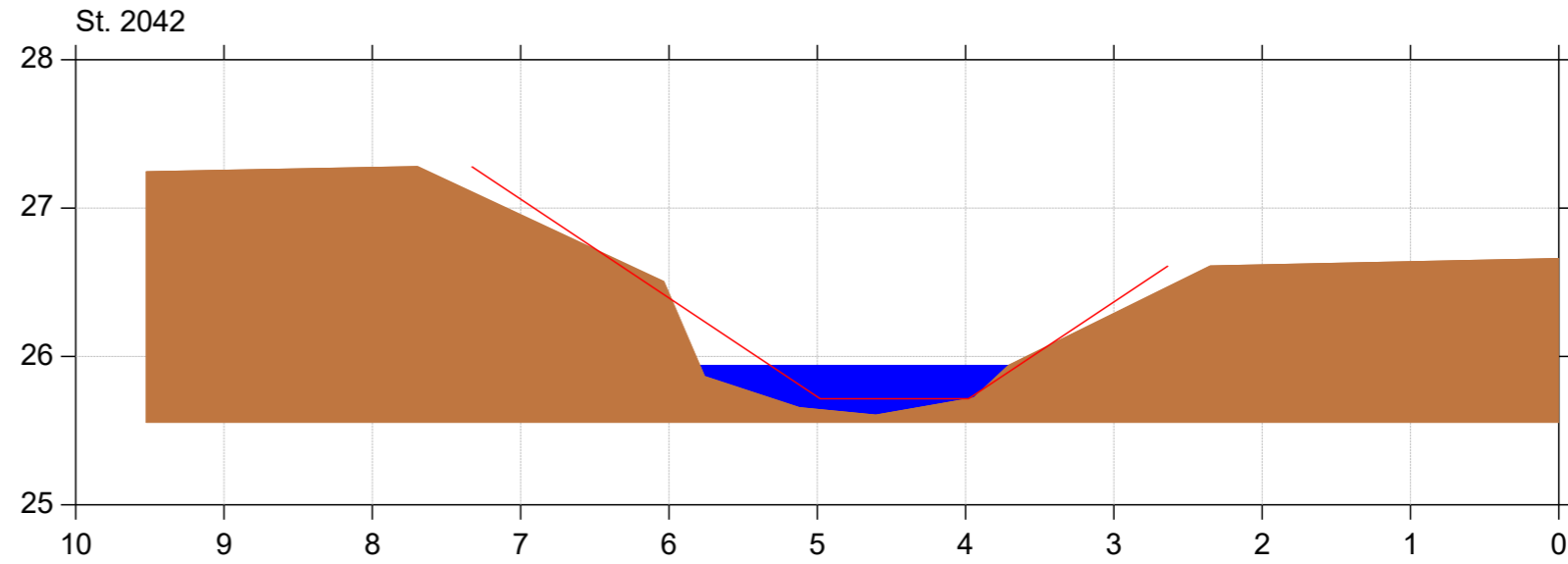
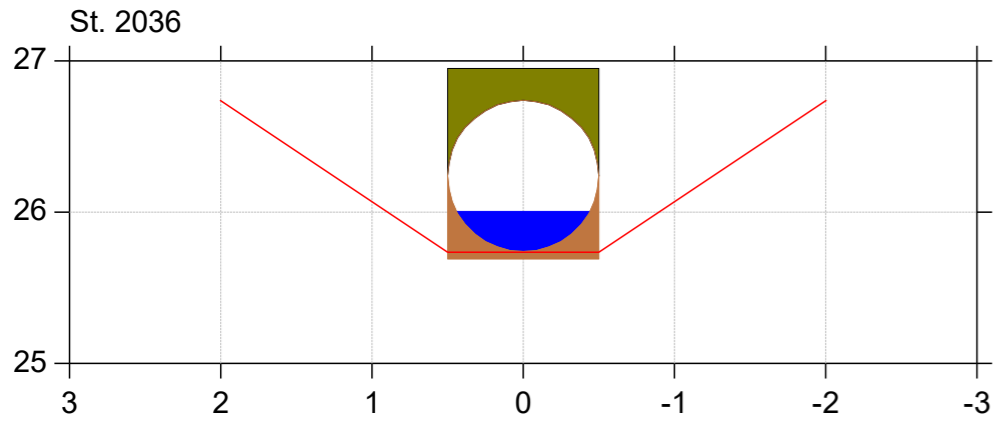

Almstrup Bæk

Regulativrevision

Lodret akse : Kote i m DVR90, skala 1:50

Vandret akse : Afstand i m, skala 1:50

- Tidligere regulativ
- Regulativ
- Opmålt profil



Bilag 4.1

St. 2289

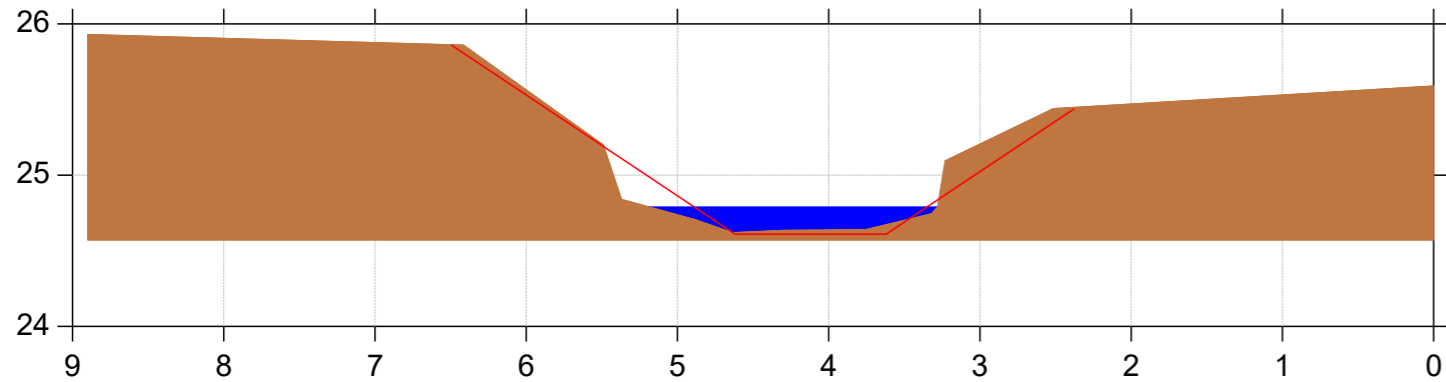

St. 2379

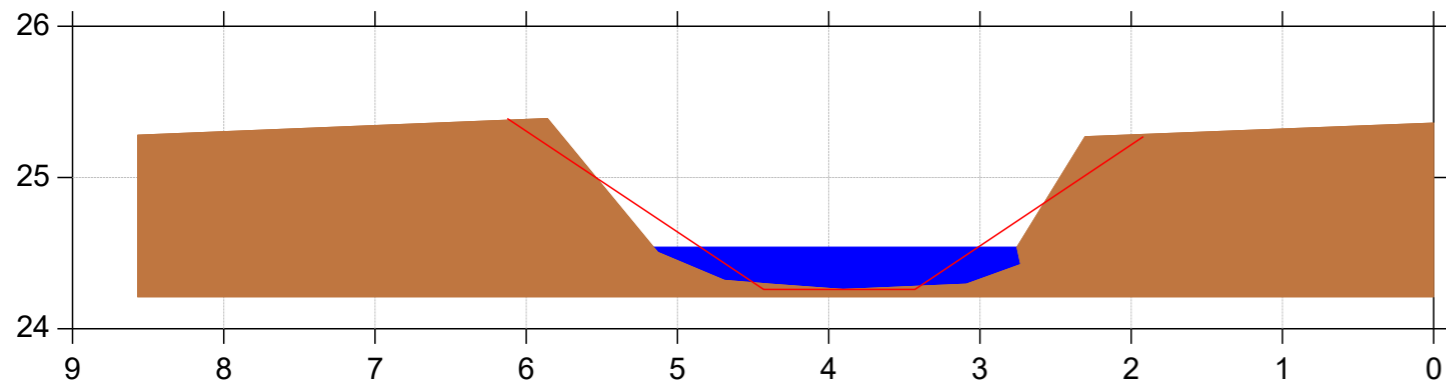

Almstrup Bæk

Regulativrevision

Lodret akse : Kote i m DVR90, skala 1:50

Vandret akse : Afstand i m, skala 1:50

- Tidligere regulativ
- Regulativ
- Opmålt profil



Bilag 4.1

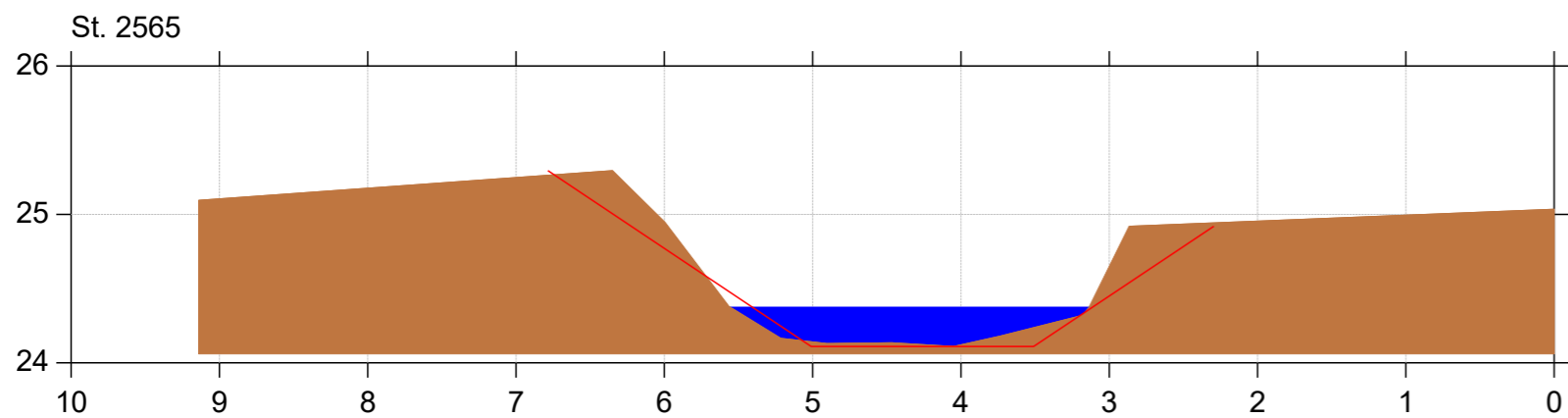
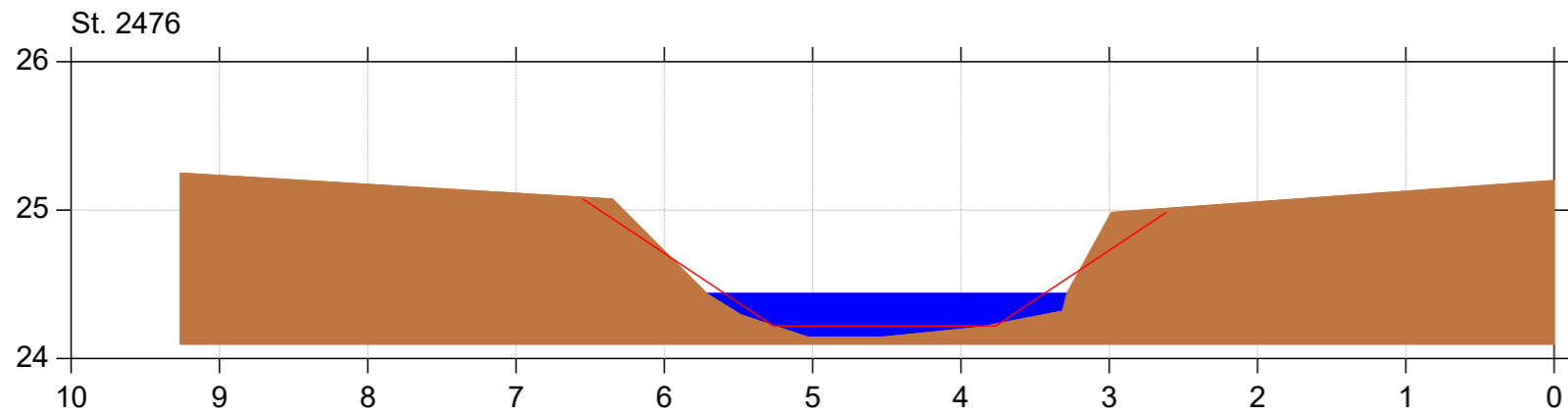

Almstrup Bæk

Regulativrevision

Lodret akse : Kote i m DVR90, skala 1:50

Vandret akse : Afstand i m, skala 1:50

- Tidligere regulativ
- Regulativ
- Opmålt profil



Bilag 4.1

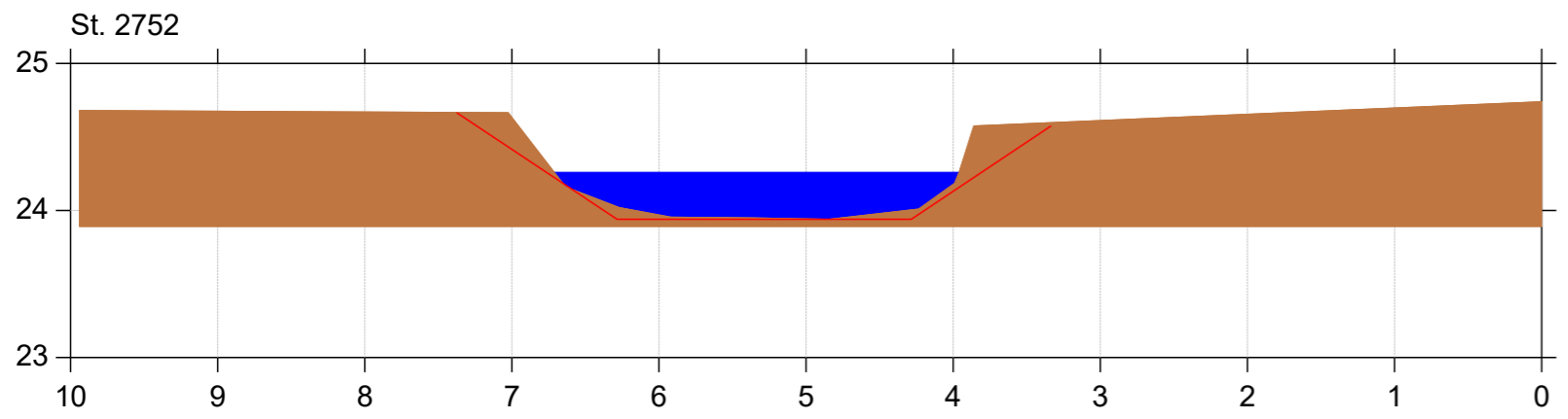
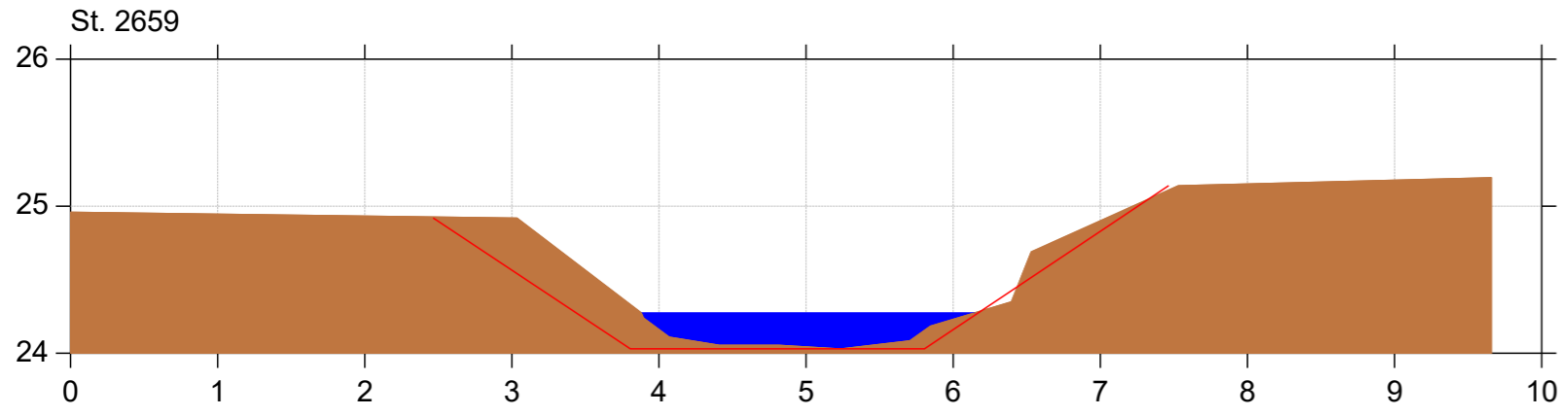

Almstrup Bæk

Regulativrevision

Lodret akse : Kote i m DVR90, skala 1:50

Vandret akse : Afstand i m, skala 1:50

- Tidligere regulativ
- Regulativ
- Opmålt profil



Bilag 4.1

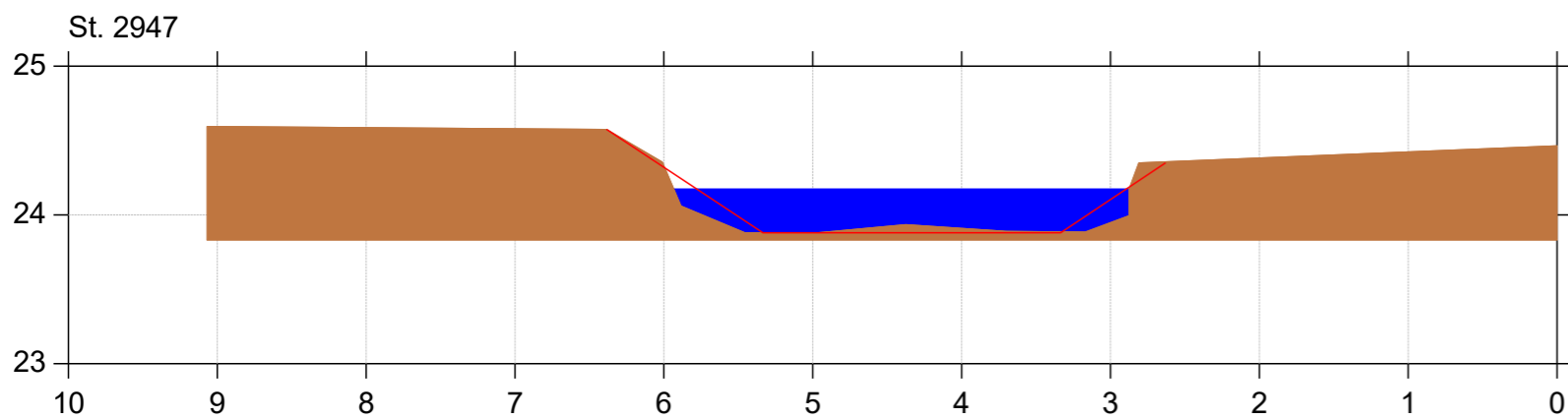
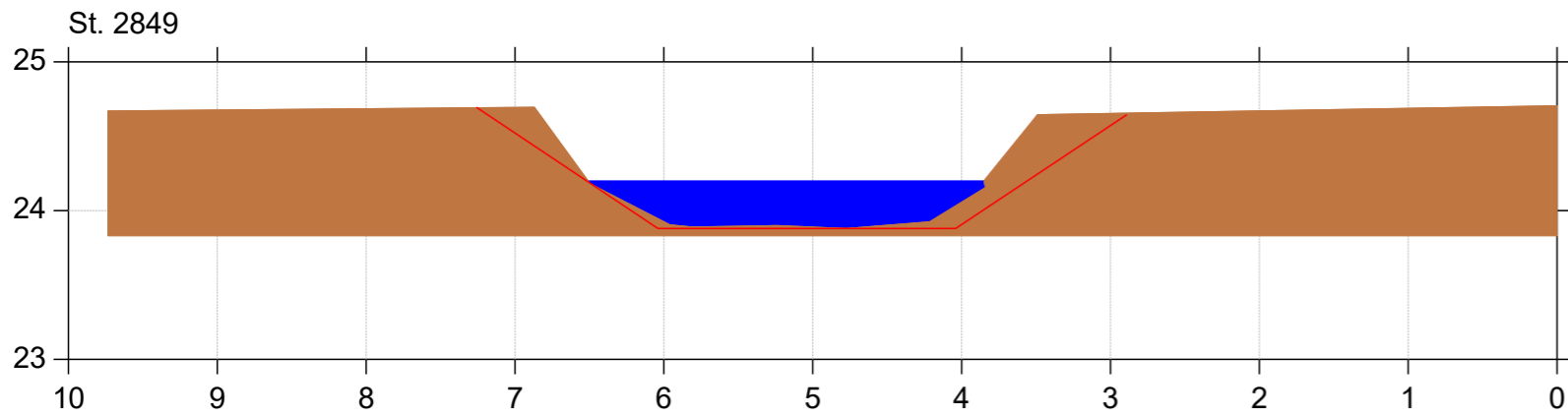

Almstrup Bæk

Regulativrevision

Lodret akse : Kote i m DVR90, skala 1:50

Vandret akse : Afstand i m, skala 1:50

- Tidligere regulativ
- Regulativ
- Opmålt profil



Bilag 4.1

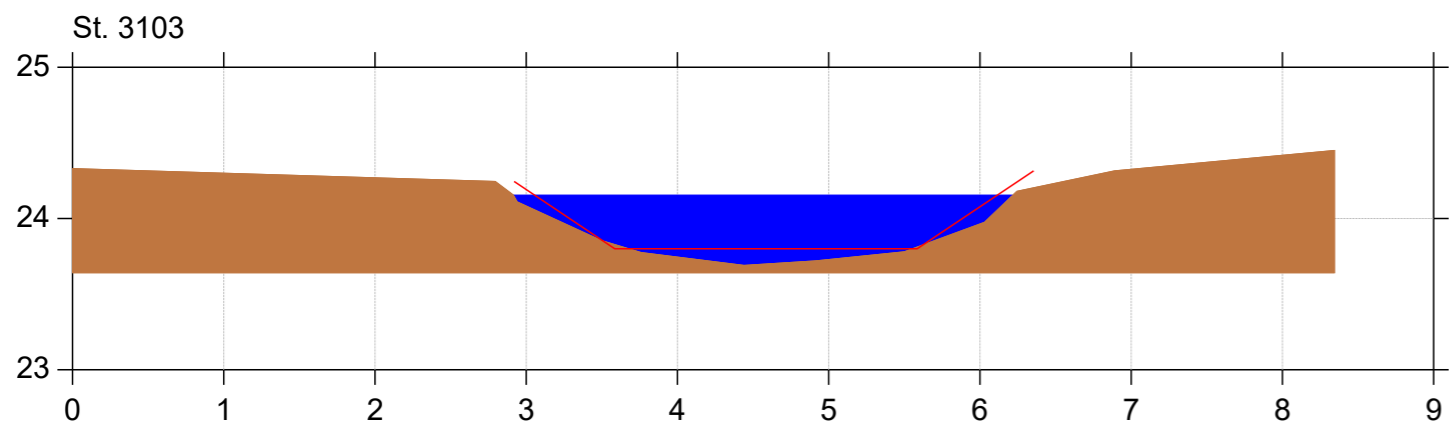
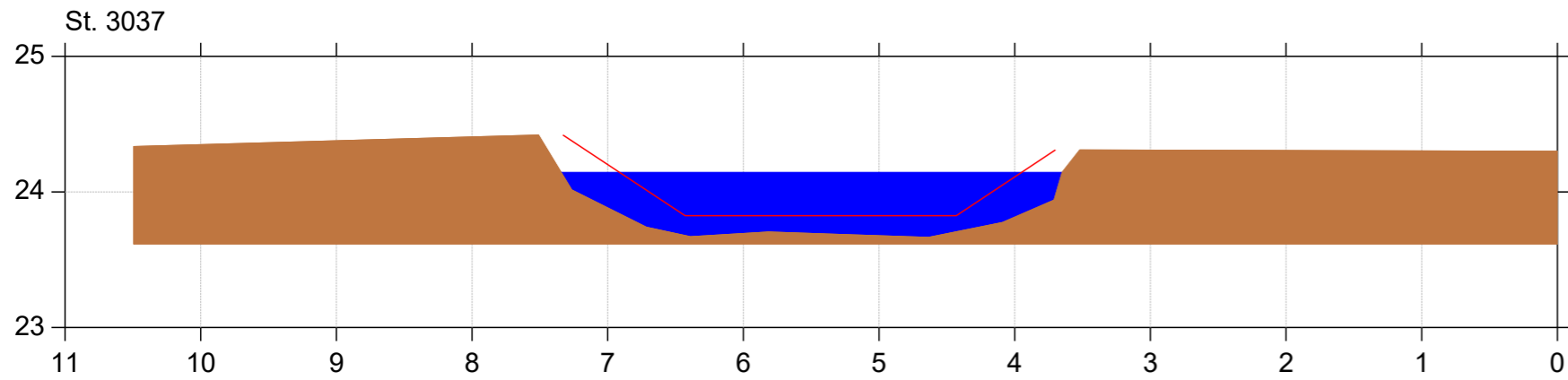

Almstrup Bæk

Regulativrevision

Lodret akse : Kote i m DVR90, skala 1:50

Vandret akse : Afstand i m, skala 1:50

- Tidligere regulativ
- Regulativ
- Opmålt profil

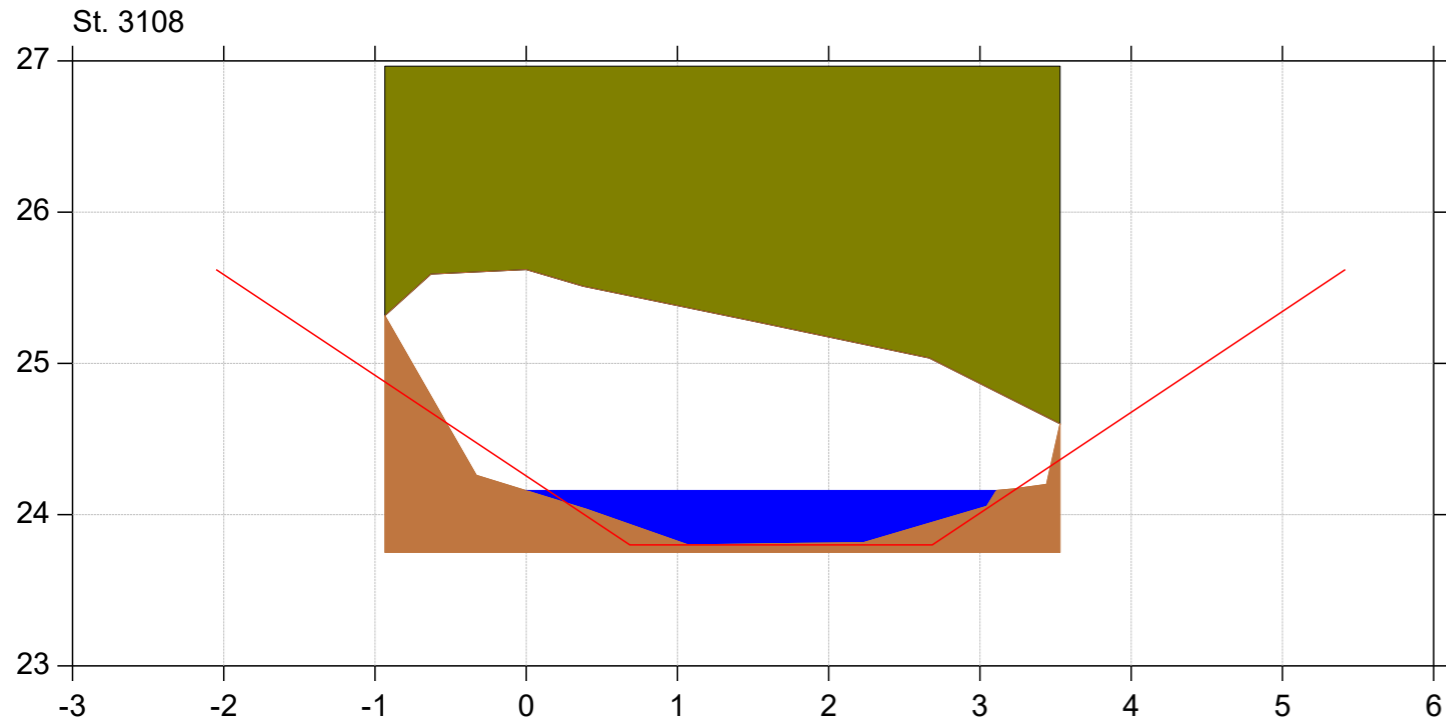

Almstrup Bæk

Regulativrevision

Lodret akse : Kote i m DVR90, skala 1:50

Vandret akse : Afstand i m, skala 1:50

- Tidligere regulativ
- Regulativ
- Opmålt profil



Bilag 4.1

St. 3136

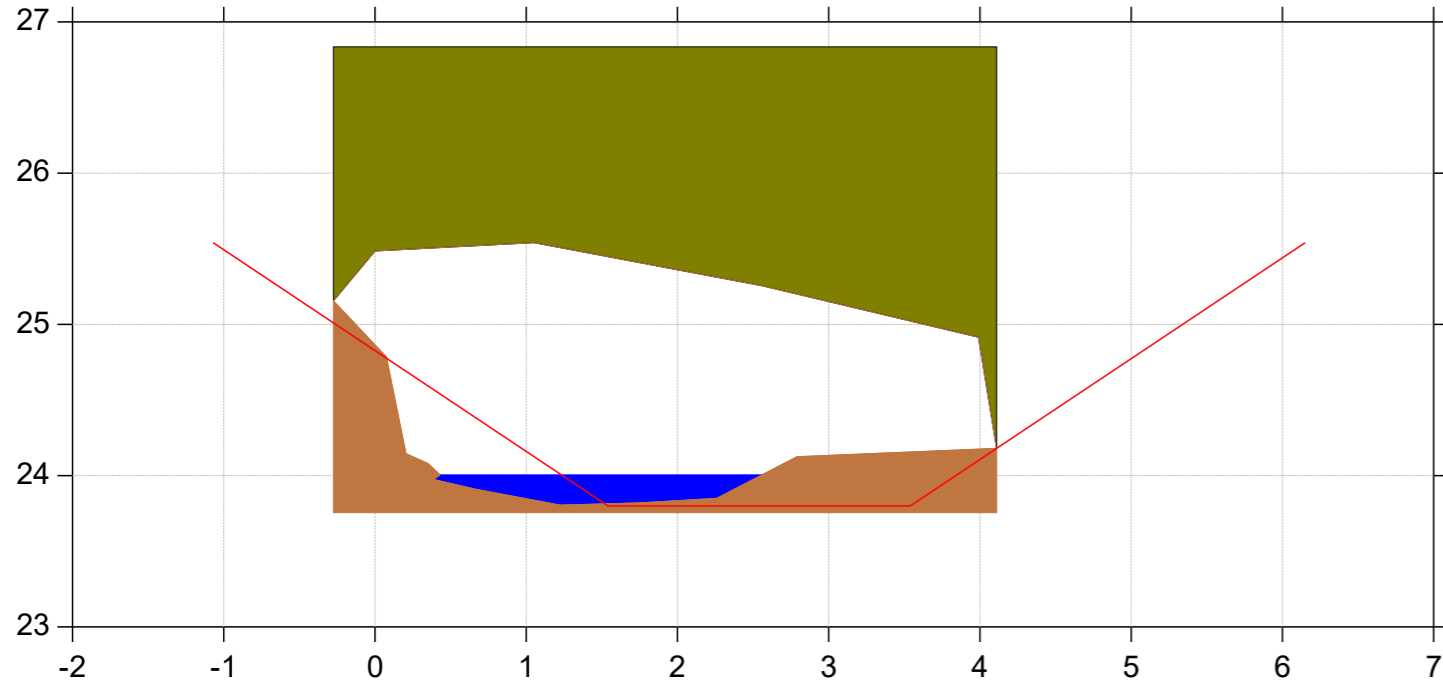

St. 3246

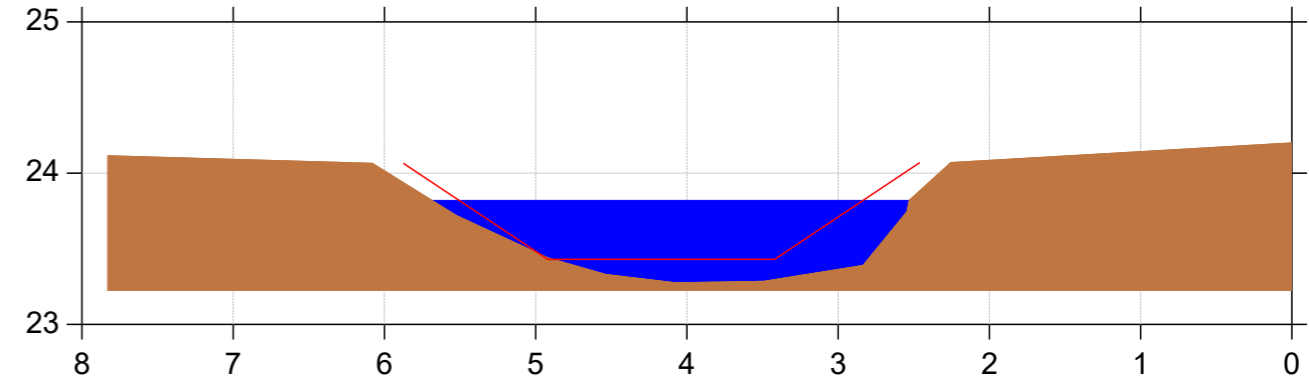

St. 3356

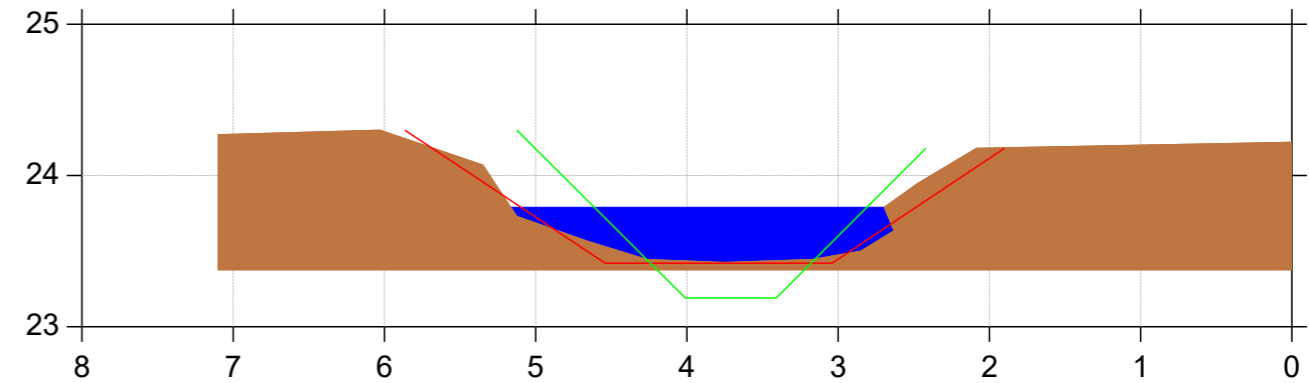

St. 3151

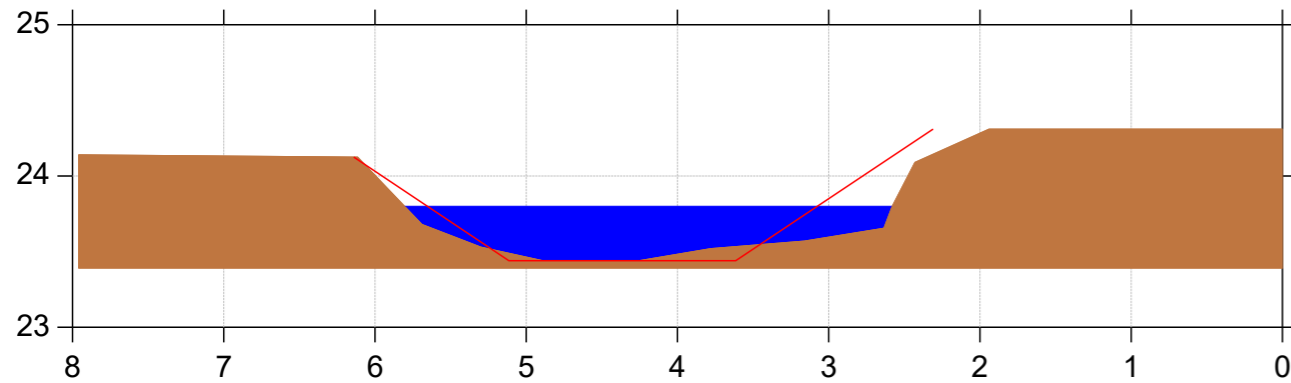

Almstrup Bæk

Regulativrevision

Lodret akse : Kote i m DVR90, skala 1:50

Vandret akse : Afstand i m, skala 1:50

- Tidligere regulativ
- Regulativ
- Opmålt profil



Bilag 4.1

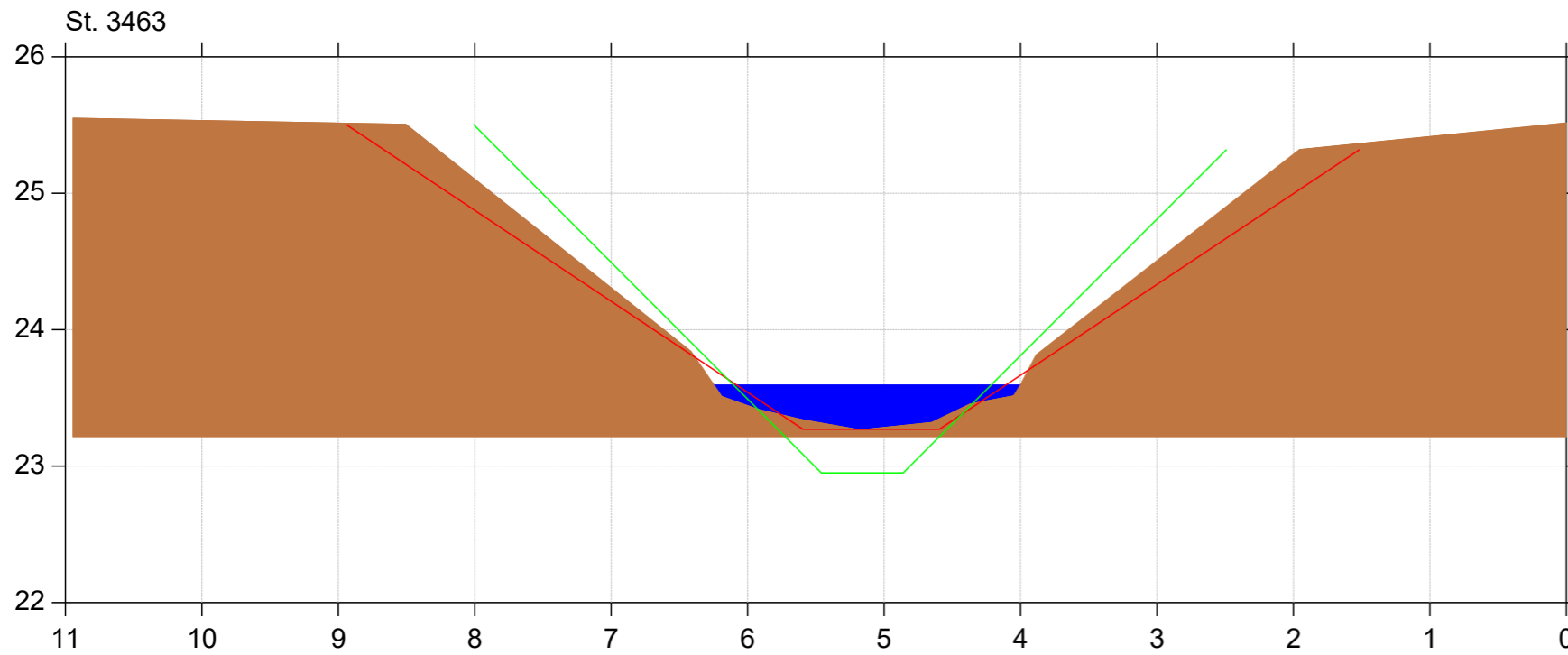

Almstrup Bæk

Regulativrevision

Lodret akse : Kote i m DVR90, skala 1:50

Vandret akse : Afstand i m, skala 1:50

- Tidligere regulativ
- Regulativ
- Opmålt profil



Bilag 4.1

St. 3567

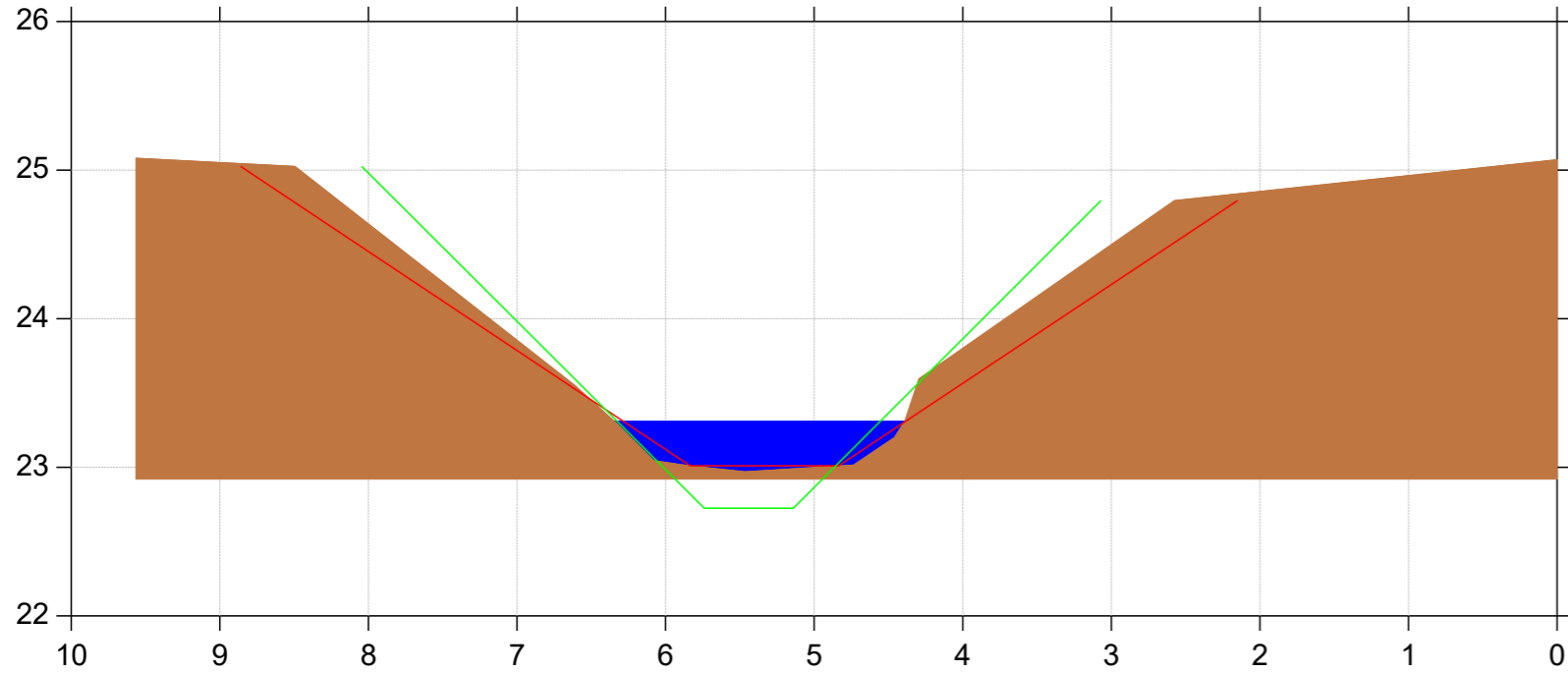

St. 3696

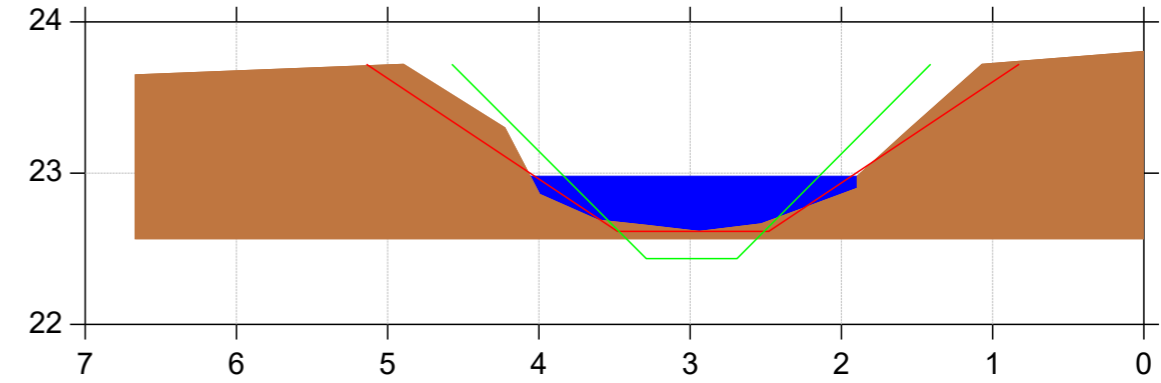

St. 3698

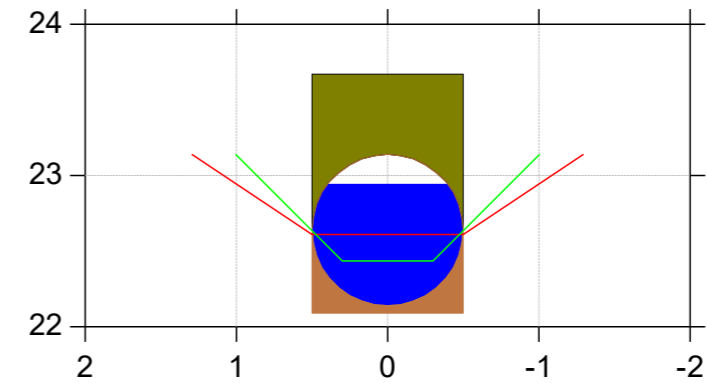

St. 3672

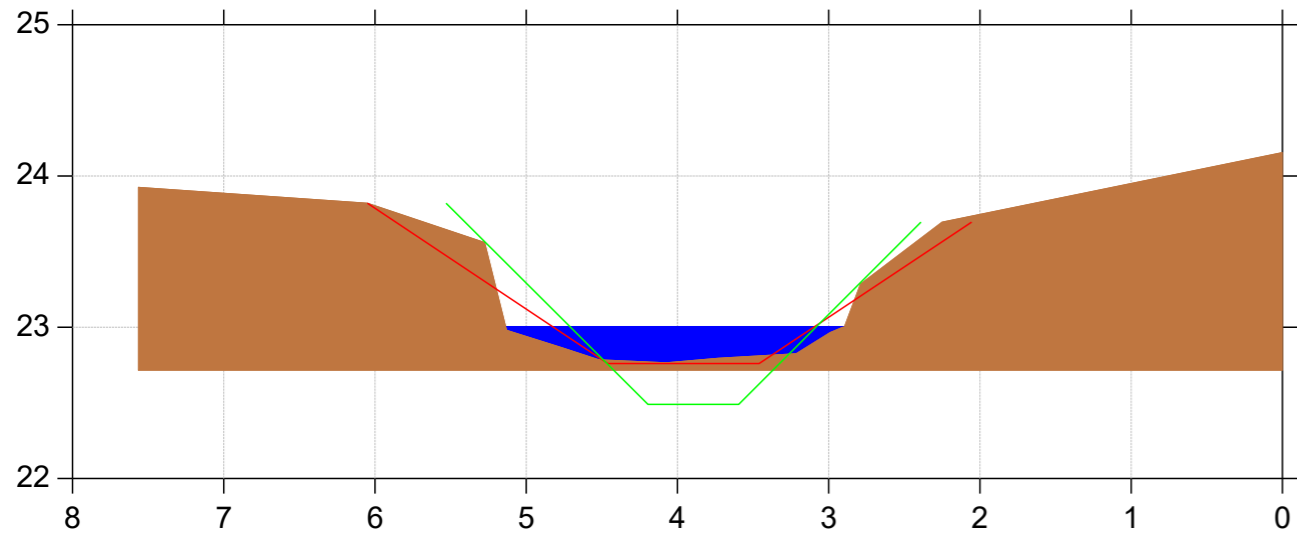

Almstrup Bæk

Regulativrevision

Lodret akse : Kote i m DVR90, skala 1:50

Vandret akse : Afstand i m, skala 1:50

- Tidligere regulativ
- Regulativ
- Opmålt profil



Bilag 4.1

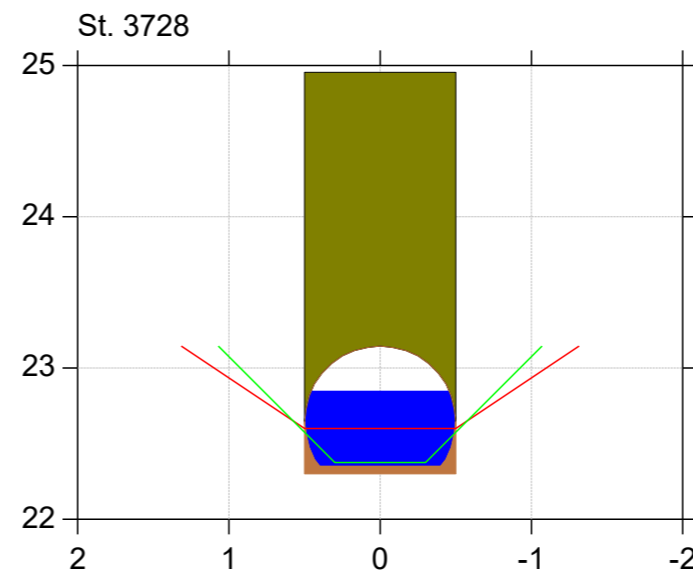
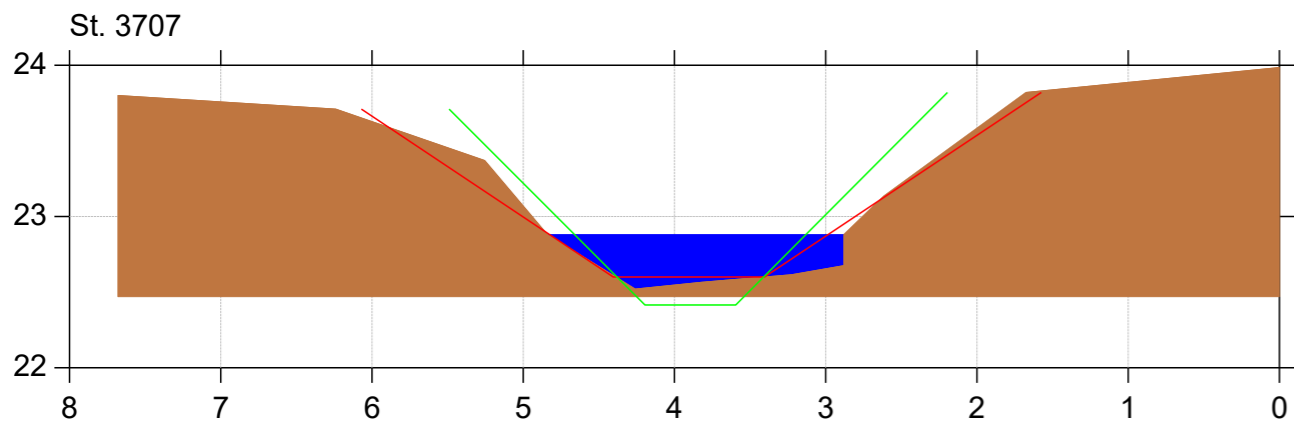
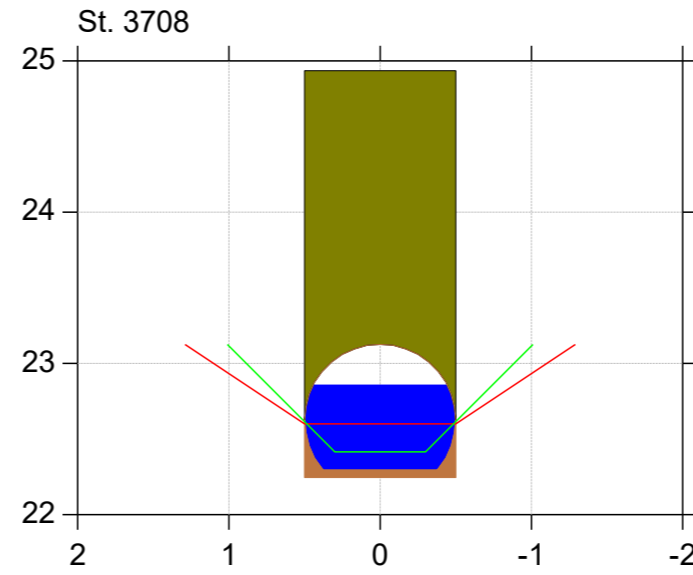
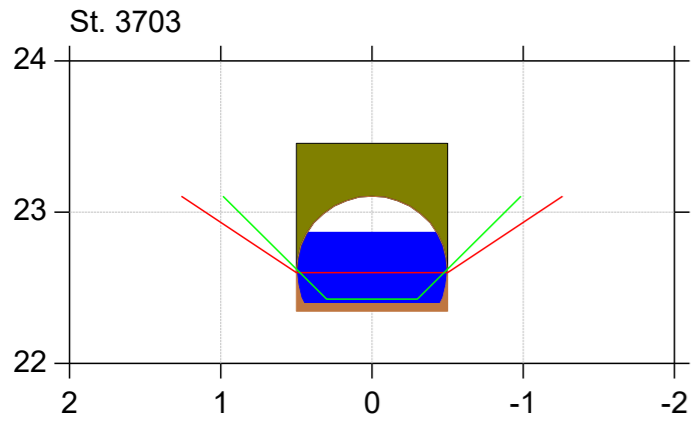

Almstrup Bæk

Regulativrevision

Lodret akse : Kote i m DVR90, skala 1:50

Vandret akse : Afstand i m, skala 1:50

- Tidligere regulativ
- Regulativ
- Opmålt profil



Bilag 4.1

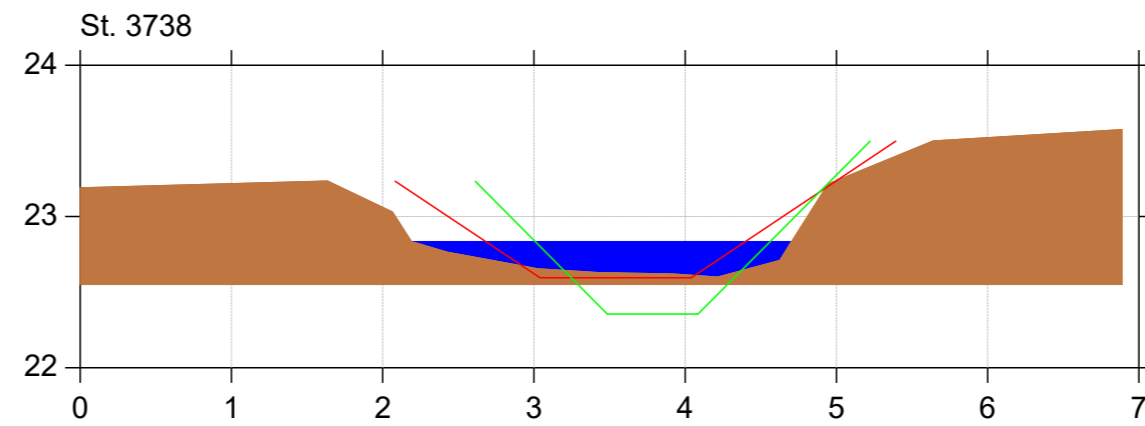
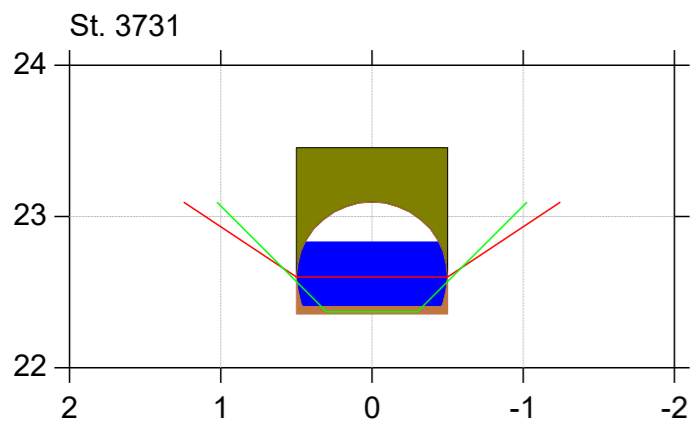
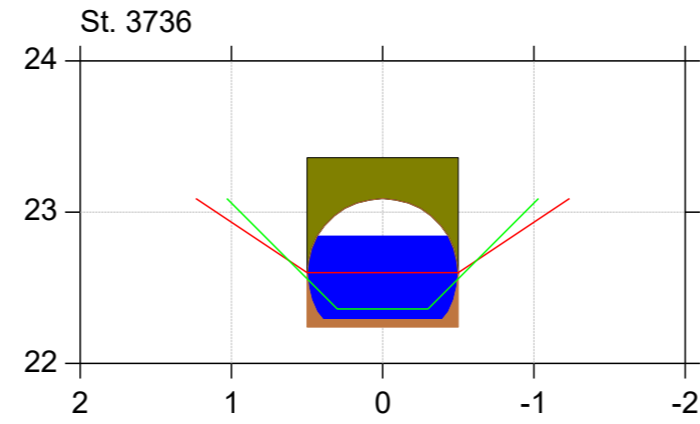
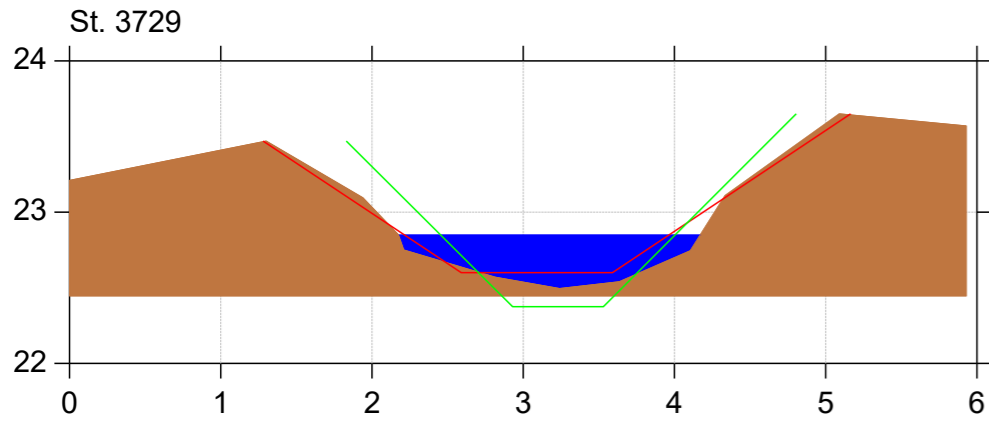

Almstrup Bæk

Regulativrevision

Lodret akse : Kote i m DVR90, skala 1:50

Vandret akse : Afstand i m, skala 1:50

- Tidligere regulativ
- Regulativ
- Opmålt profil



Bilag 4.1

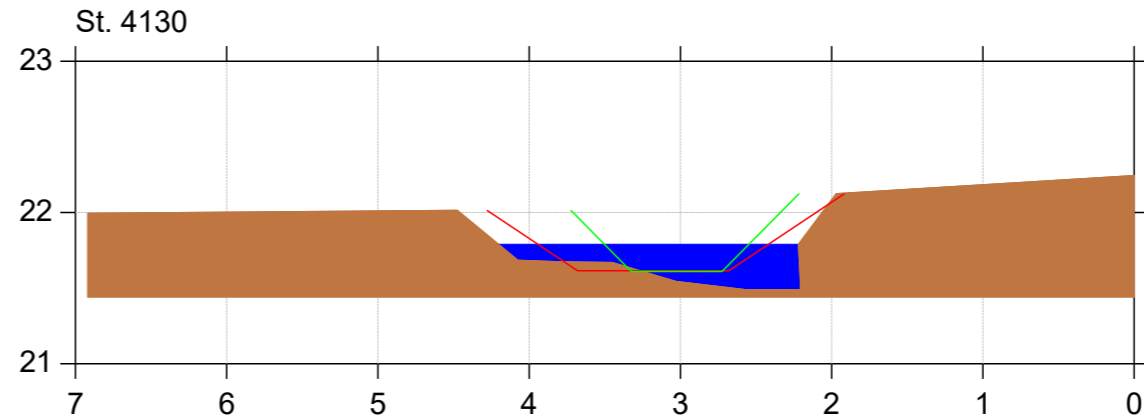
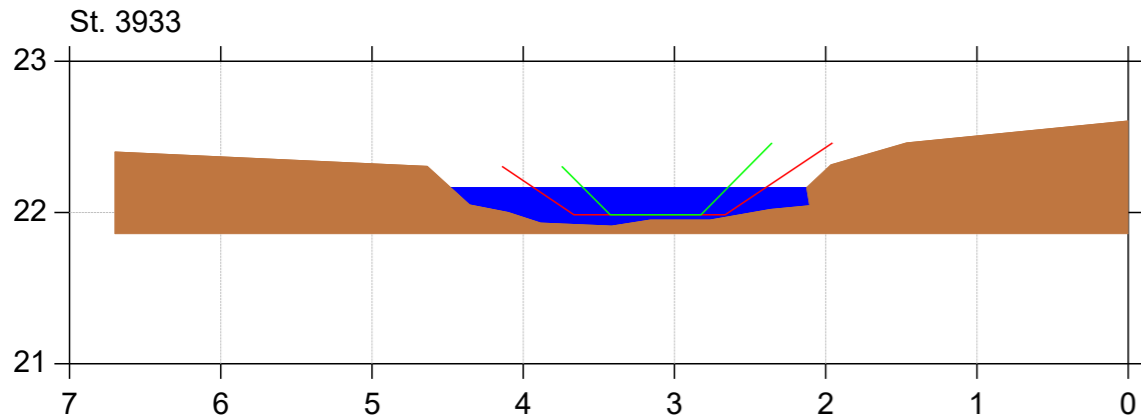
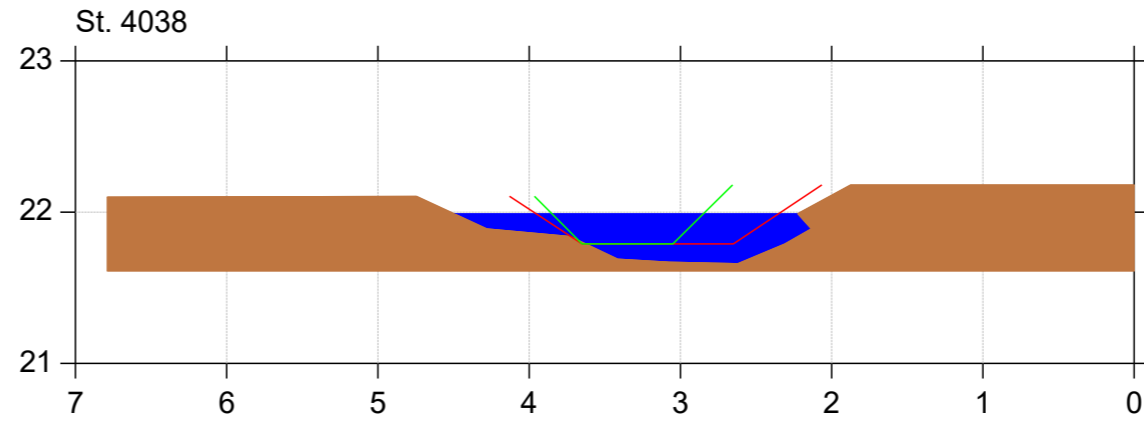
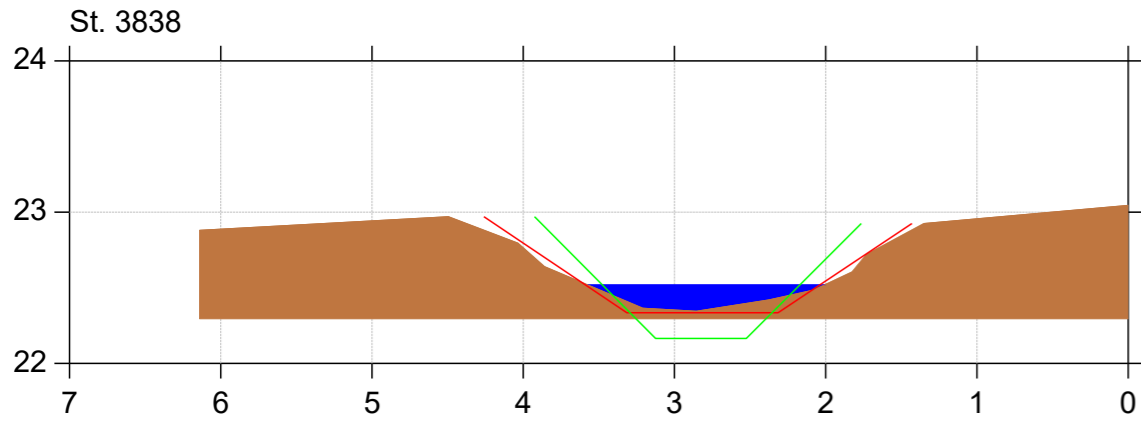

Almstrup Bæk

Regulativrevision

Lodret akse : Kote i m DVR90, skala 1:50

Vandret akse : Afstand i m, skala 1:50

- Tidligere regulativ
- Regulativ
- Opmålt profil



Bilag 4.1

St. 4217

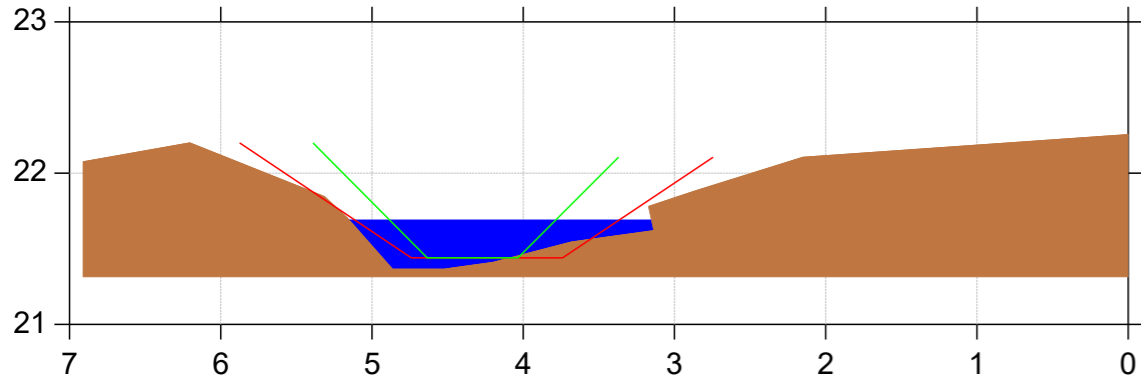

St. 4265

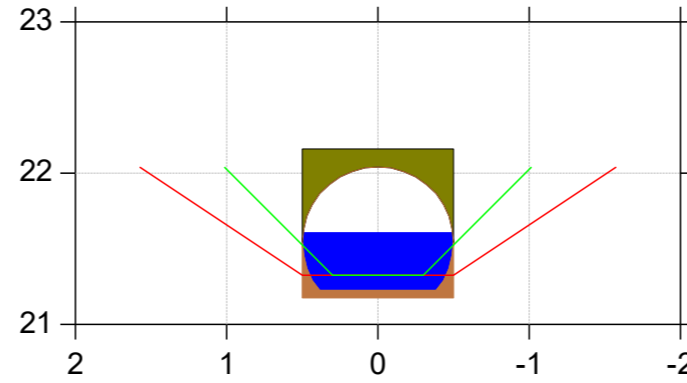

St. 4264

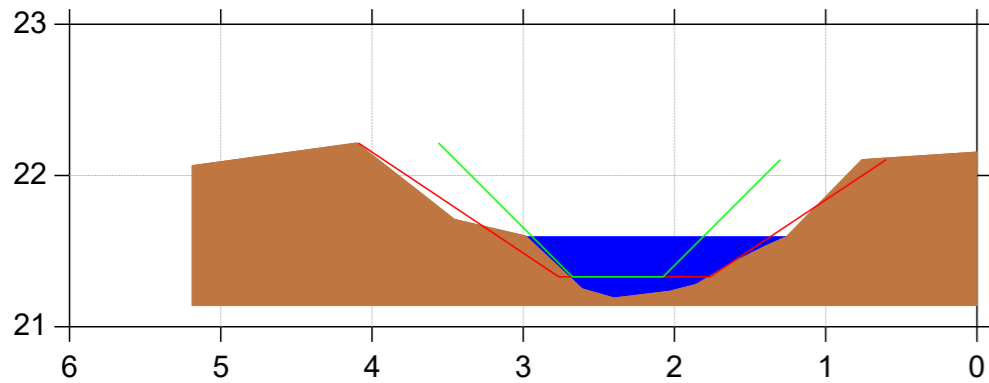

St. 4275

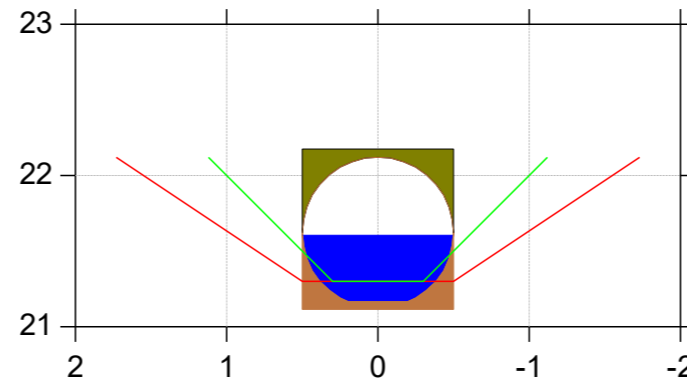

Almstrup Bæk

Regulativrevision

Lodret akse : Kote i m DVR90, skala 1:50

Vandret akse : Afstand i m, skala 1:50

- Tidligere regulativ
- Regulativ
- Opmålt profil



Bilag 4.1

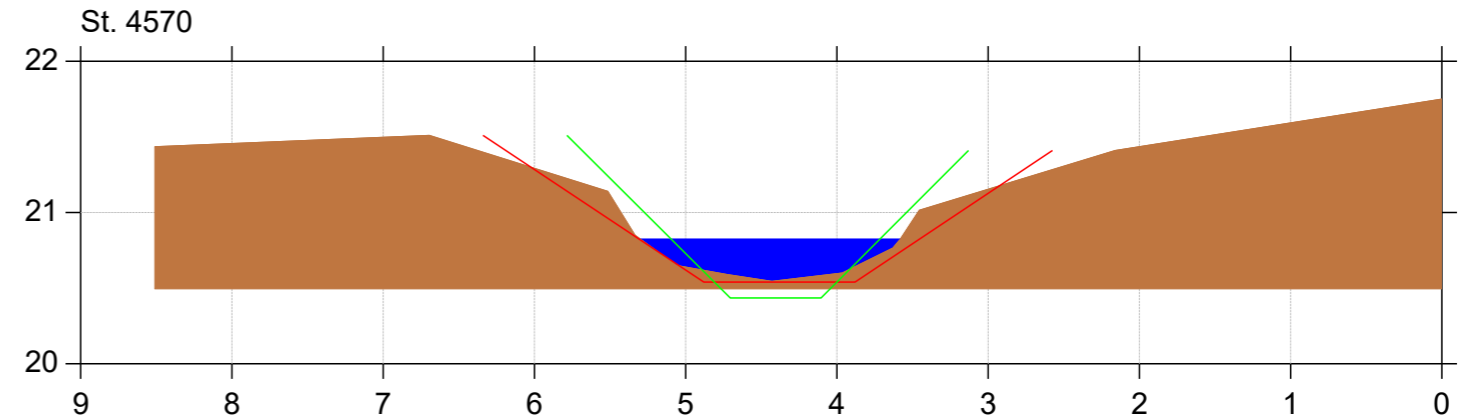
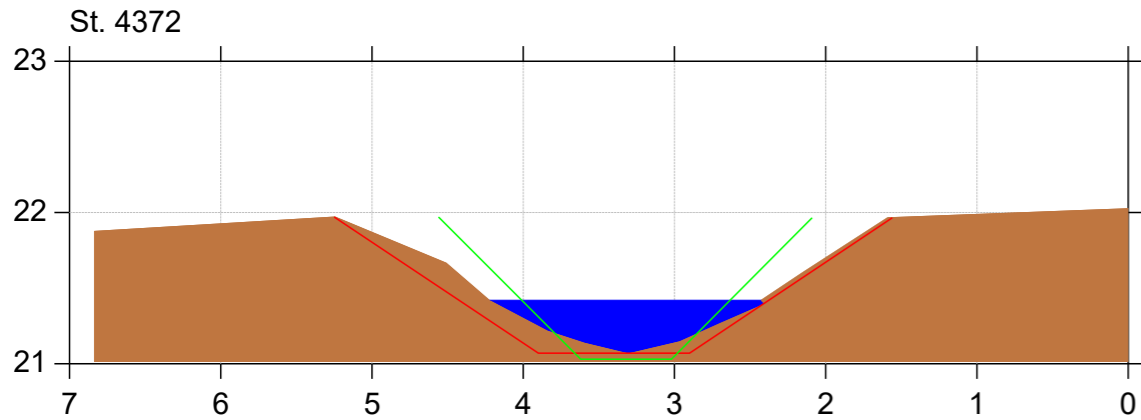
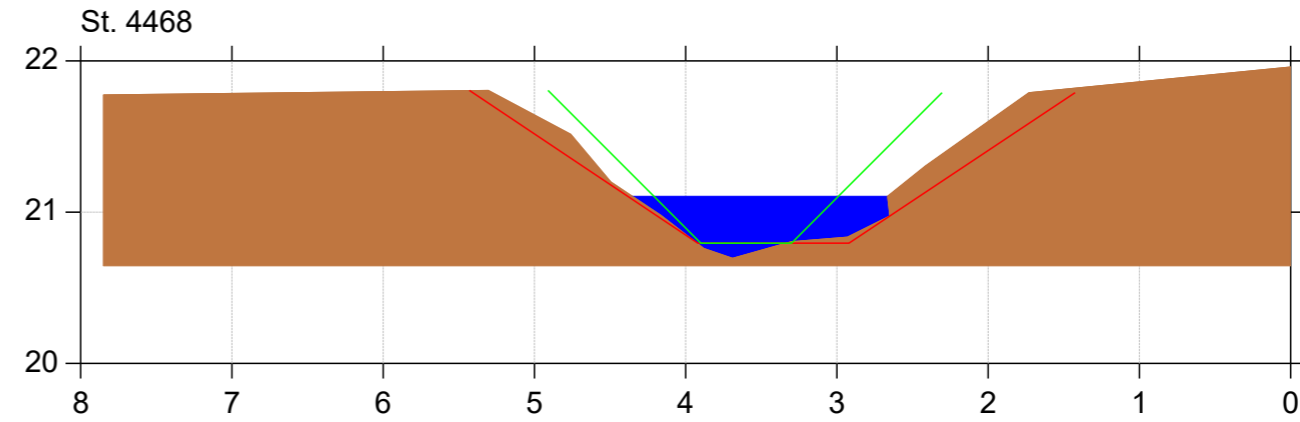
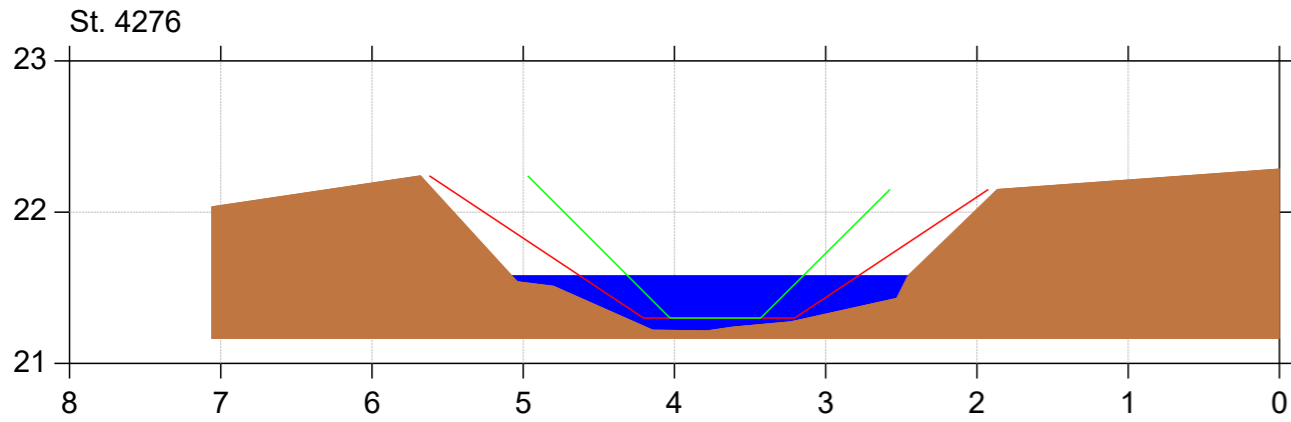

Almstrup Bæk

Regulativrevision

Lodret akse : Kote i m DVR90, skala 1:50

Vandret akse : Afstand i m, skala 1:50

- Tidligere regulativ
- Regulativ
- Opmålt profil



Bilag 4.1

St. 4672

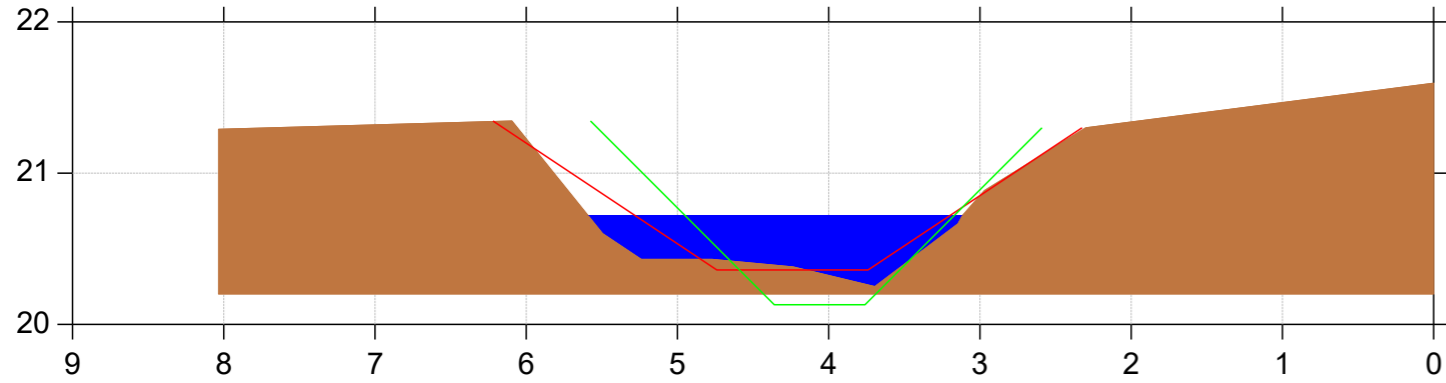

St. 4685

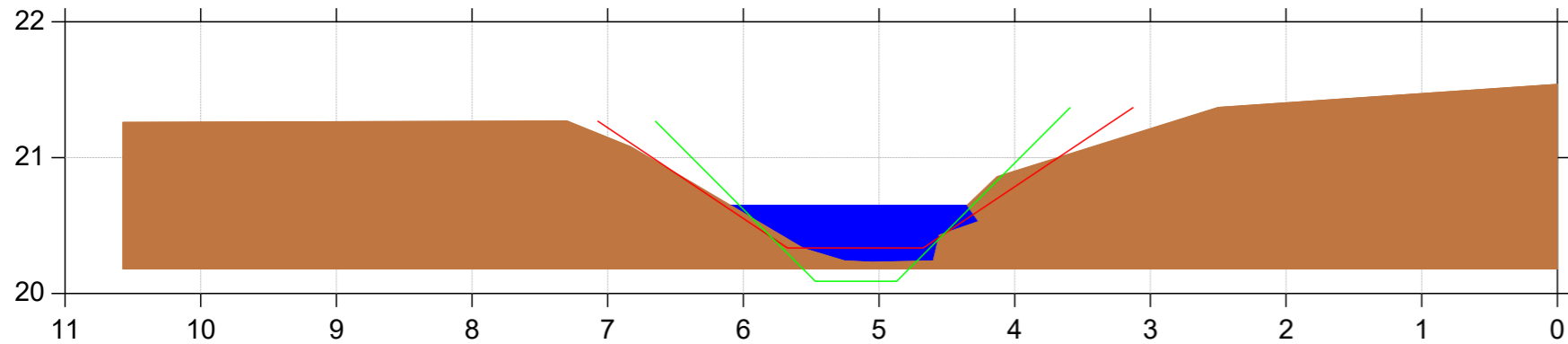

Almstrup Bæk

Regulativrevision

Lodret akse : Kote i m DVR90, skala 1:50

Vandret akse : Afstand i m, skala 1:50

- Tidligere regulativ
- Regulativ
- Opmålt profil



Bilag 4.1

St. 4723

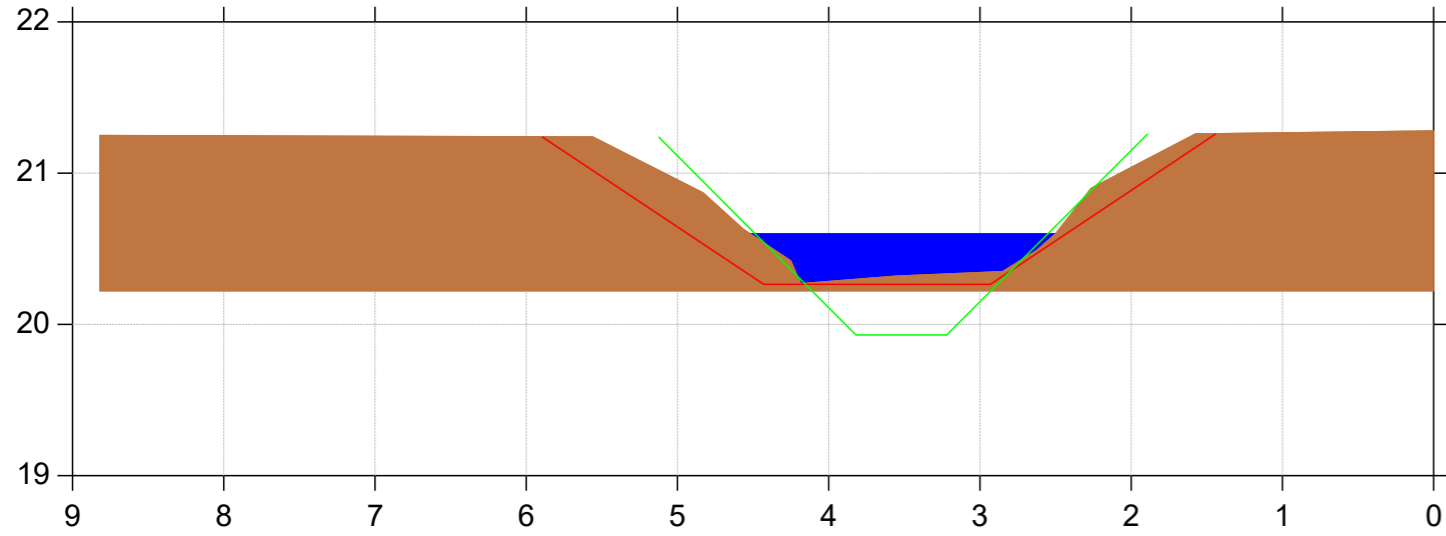

St. 4756

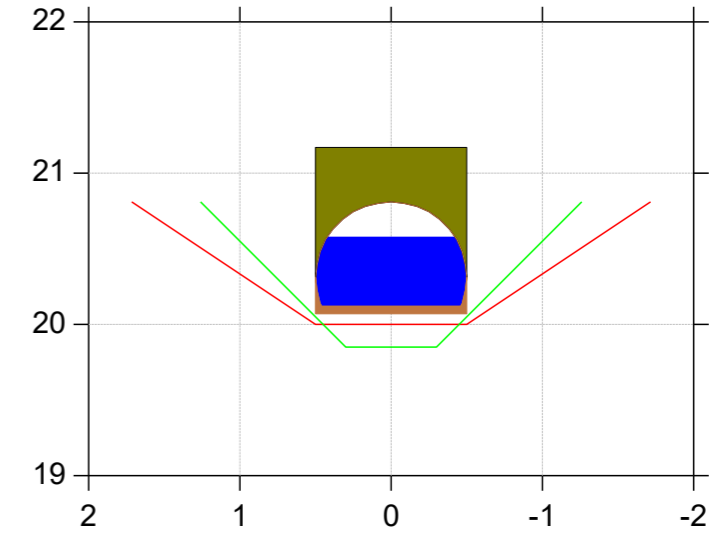

St. 4748

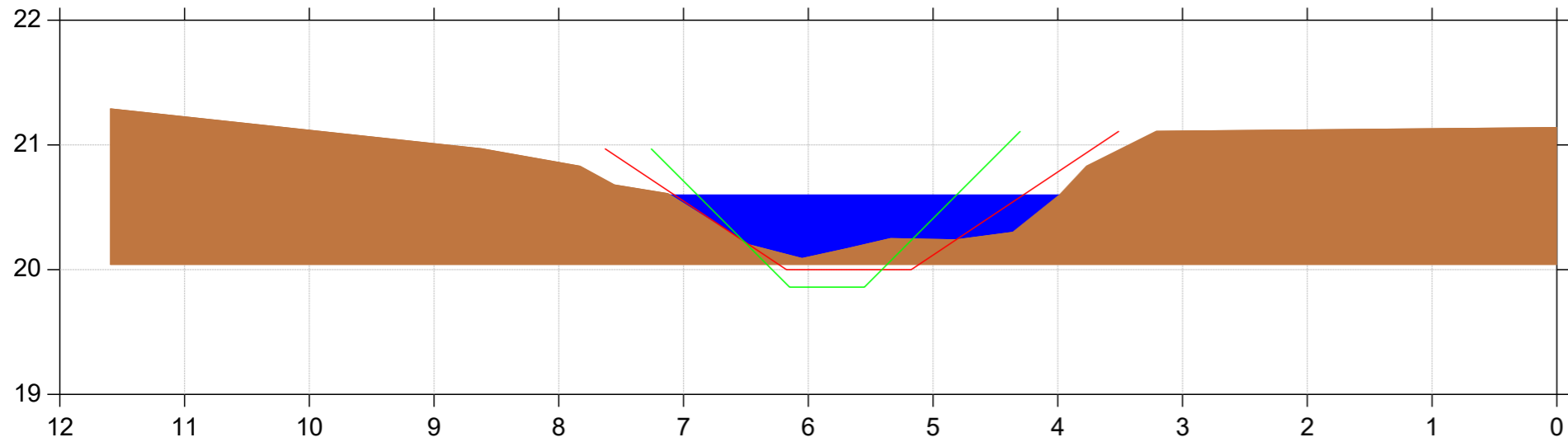

St. 4762

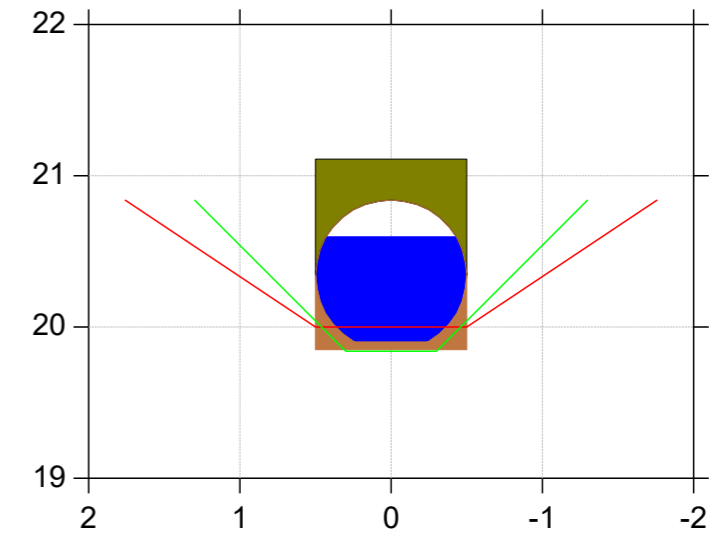

Almstrup Bæk

Regulativrevision

Lodret akse : Kote i m DVR90, skala 1:50

Vandret akse : Afstand i m, skala 1:50

- Tidligere regulativ
- Regulativ
- Opmålt profil



Bilag 4.1

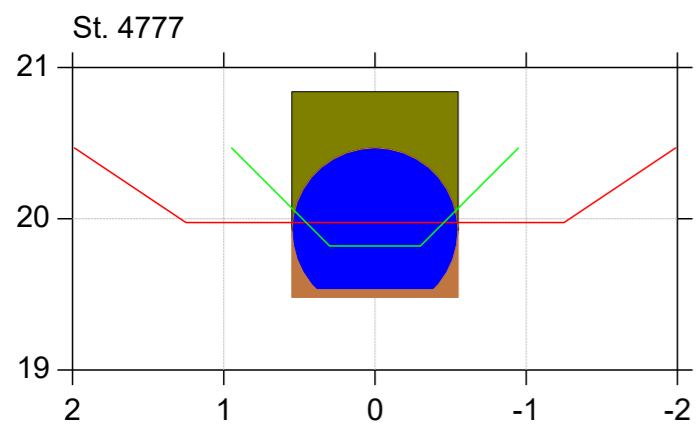
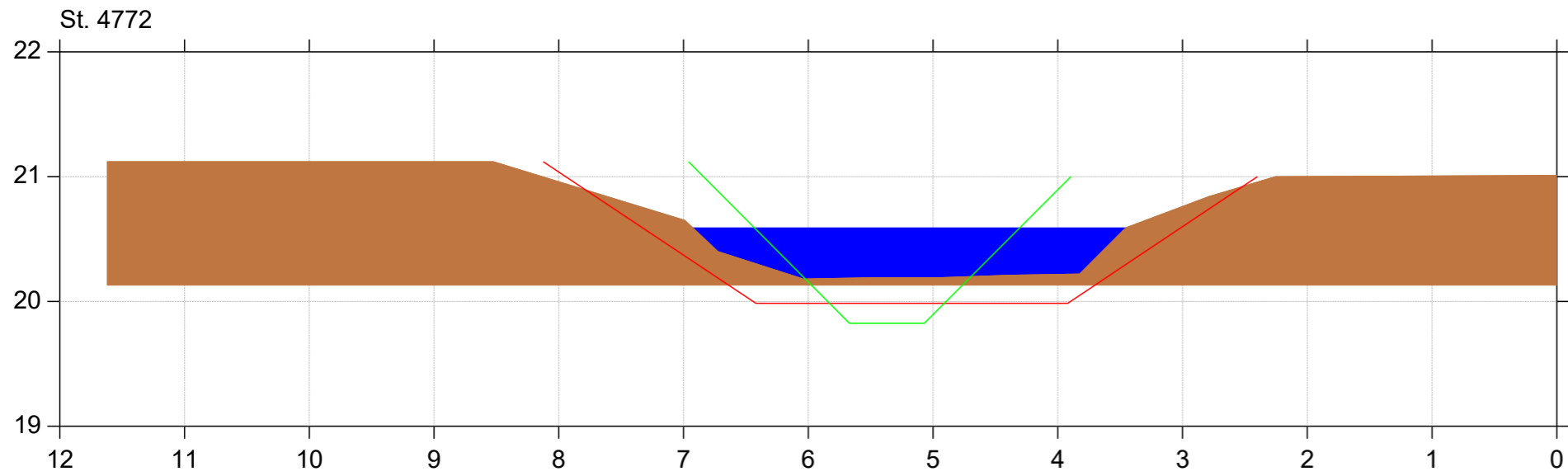

Almstrup Bæk

Regulativrevision

Lodret akse : Kote i m DVR90, skala 1:50

Vandret akse : Afstand i m, skala 1:50

- Tidligere regulativ
- Regulativ
- Opmålt profil



Bilag 4.1

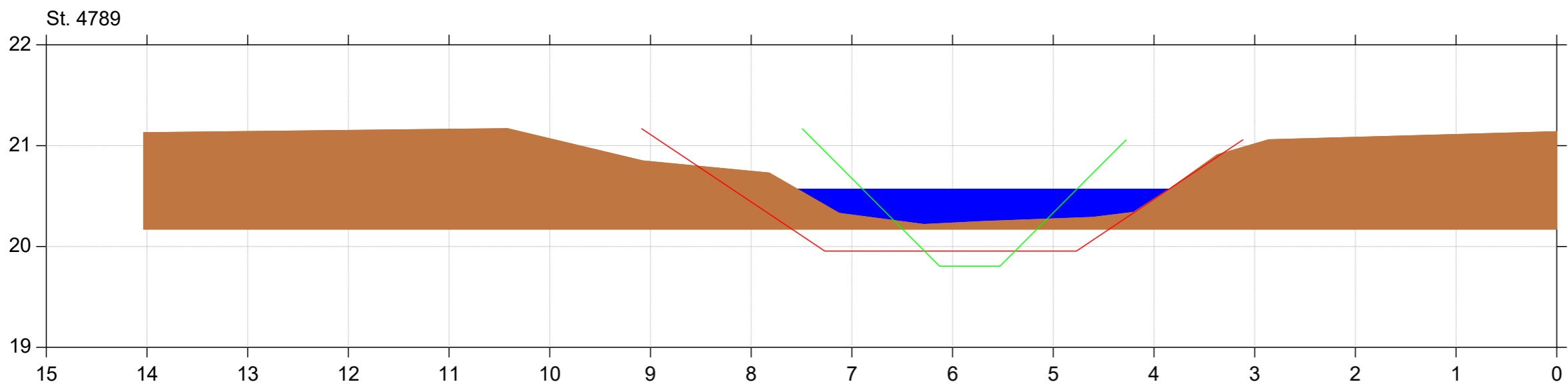
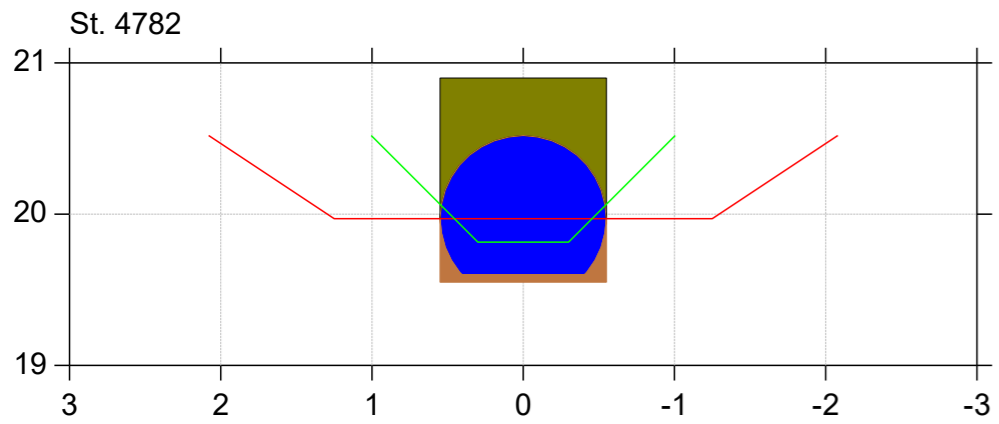

Almstrup Bæk

Regulativrevision

Lodret akse : Kote i m DVR90, skala 1:50

Vandret akse : Afstand i m, skala 1:50

- Tidligere regulativ
- Regulativ
- Opmålt profil



Bilag 4.1

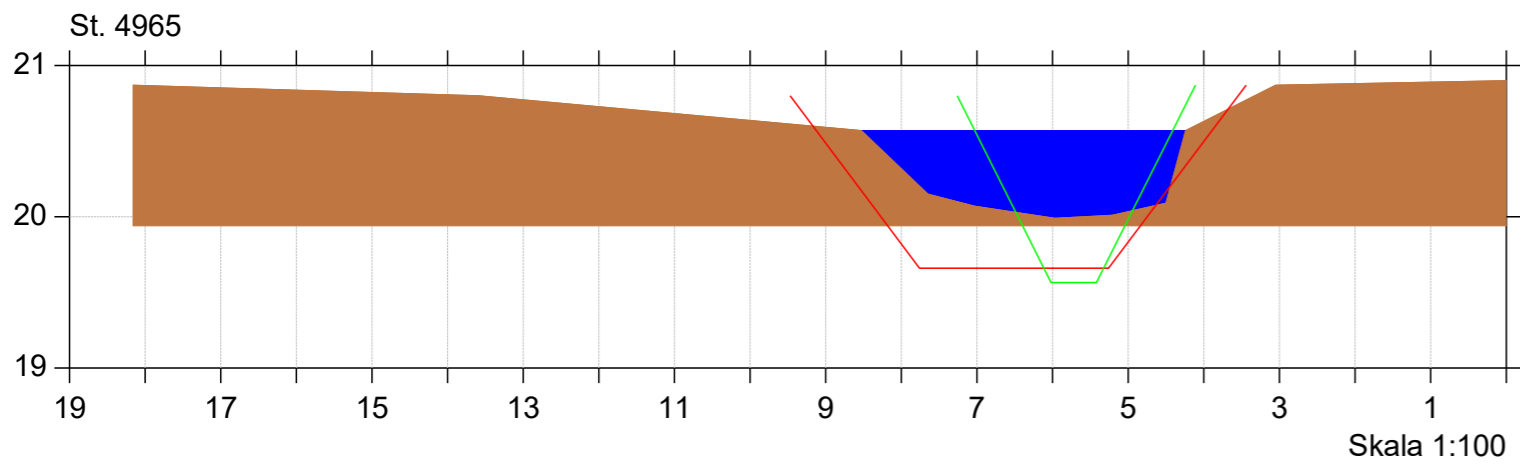
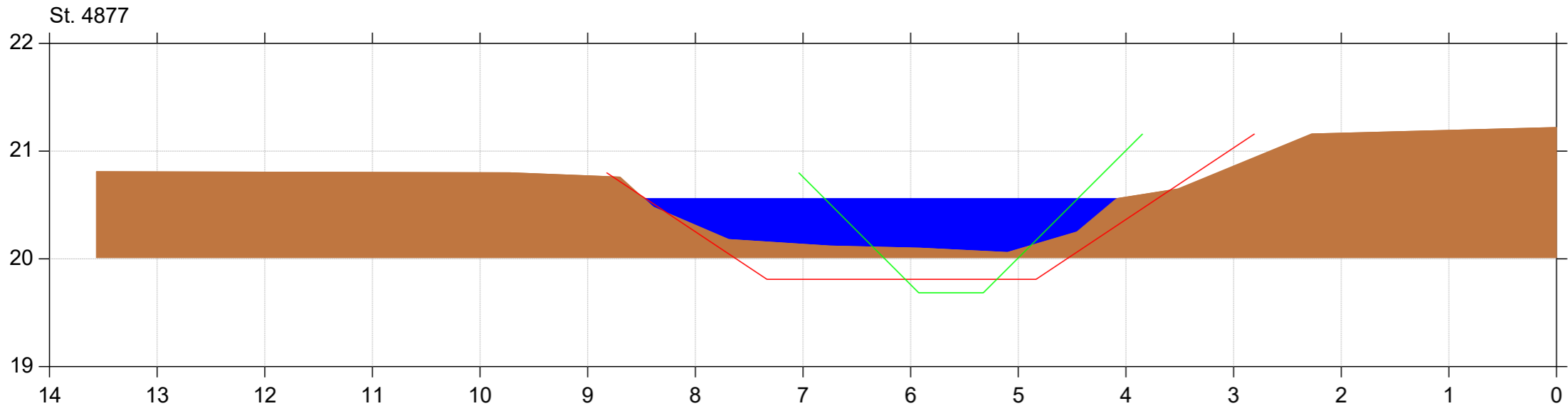

Almstrup Bæk

Regulativrevision

Lodret akse : Kote i m DVR90, skala 1:50

Vandret akse : Afstand i m, skala 1:50

- Tidligere regulativ
- Regulativ
- Opmålt profil



Bilag 4.1

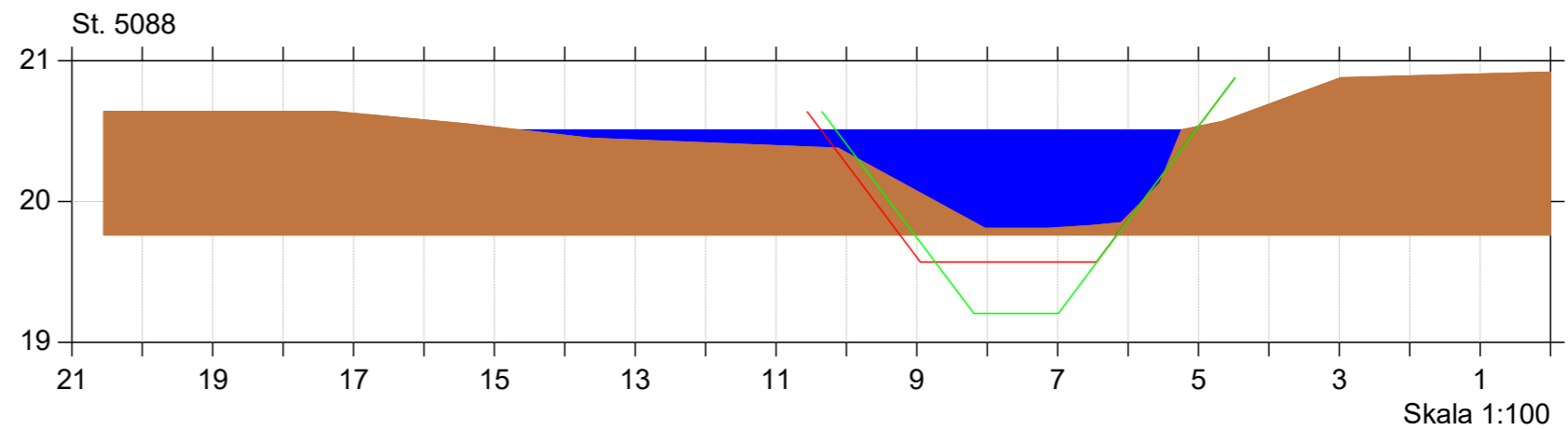
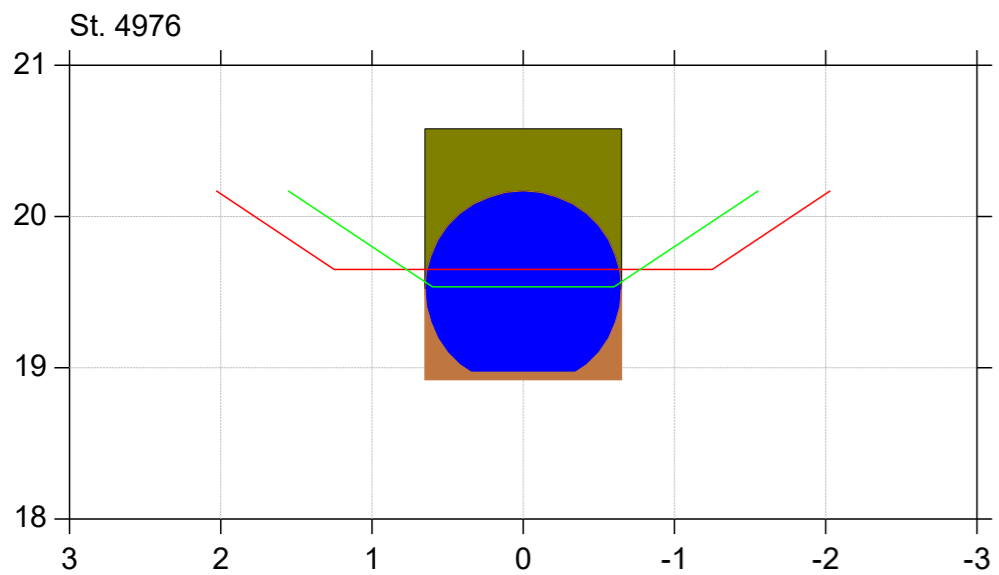
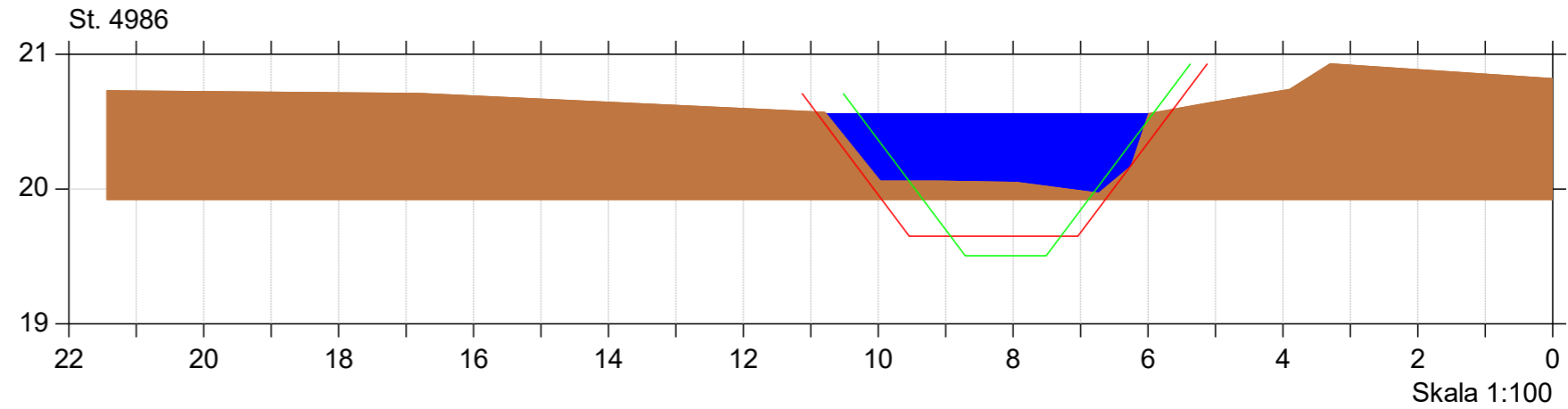
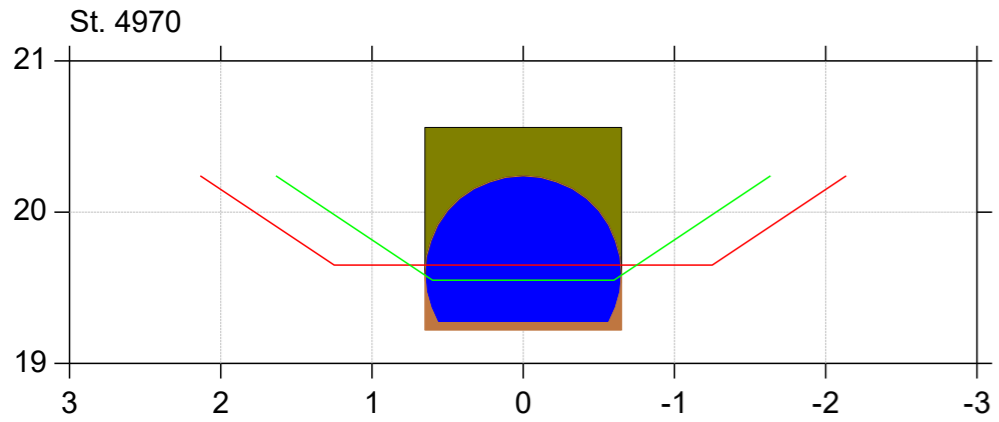

Almstrup Bæk

Regulativrevision

Lodret akse : Kote i m DVR90, skala 1:50

Vandret akse : Afstand i m, skala 1:50

- Tidligere regulativ
- Regulativ
- Opmålt profil



Bilag 4.1

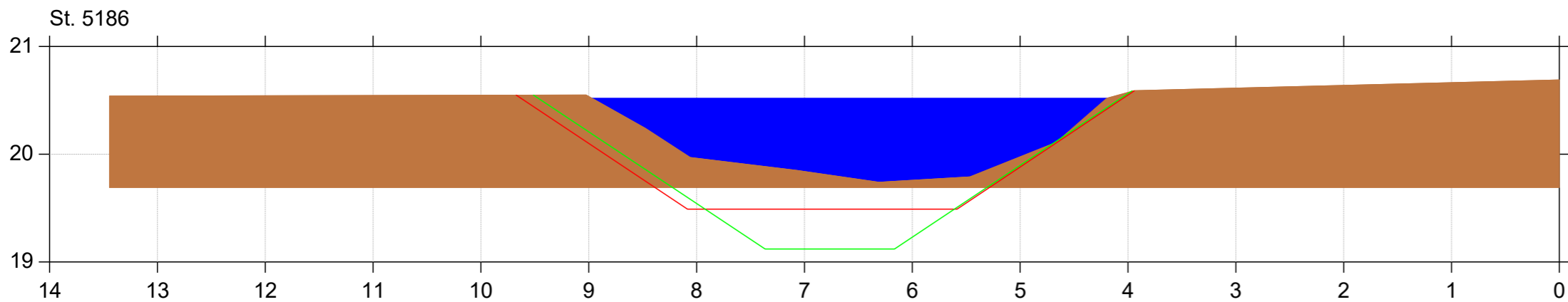
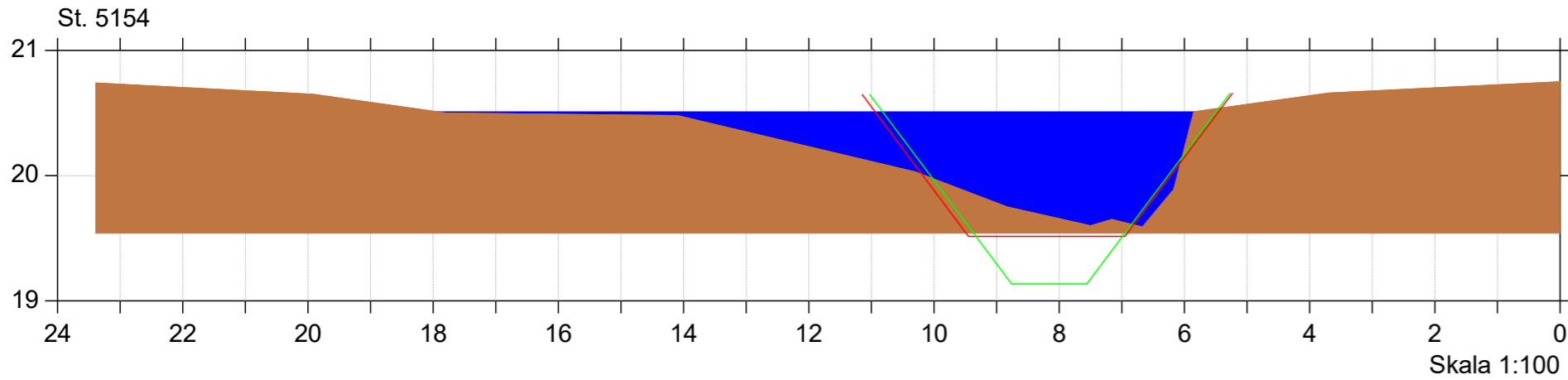

Almstrup Bæk

Regulativrevision

Lodret akse : Kote i m DVR90, skala 1:50

Vandret akse : Afstand i m, skala 1:50



Bilag 4.1

- Tidligere regulativ
- Regulativ
- Opmålt profil

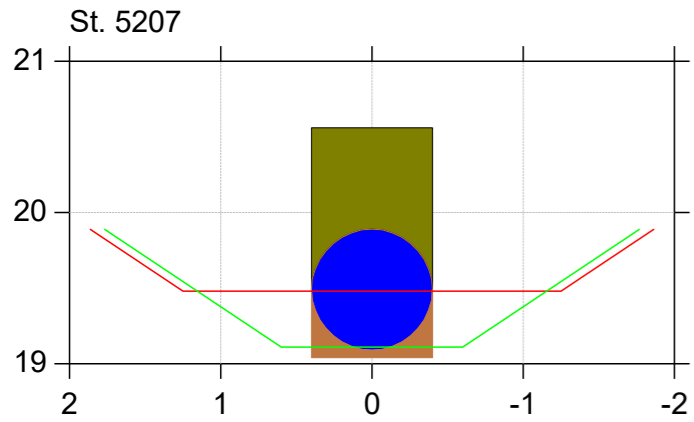
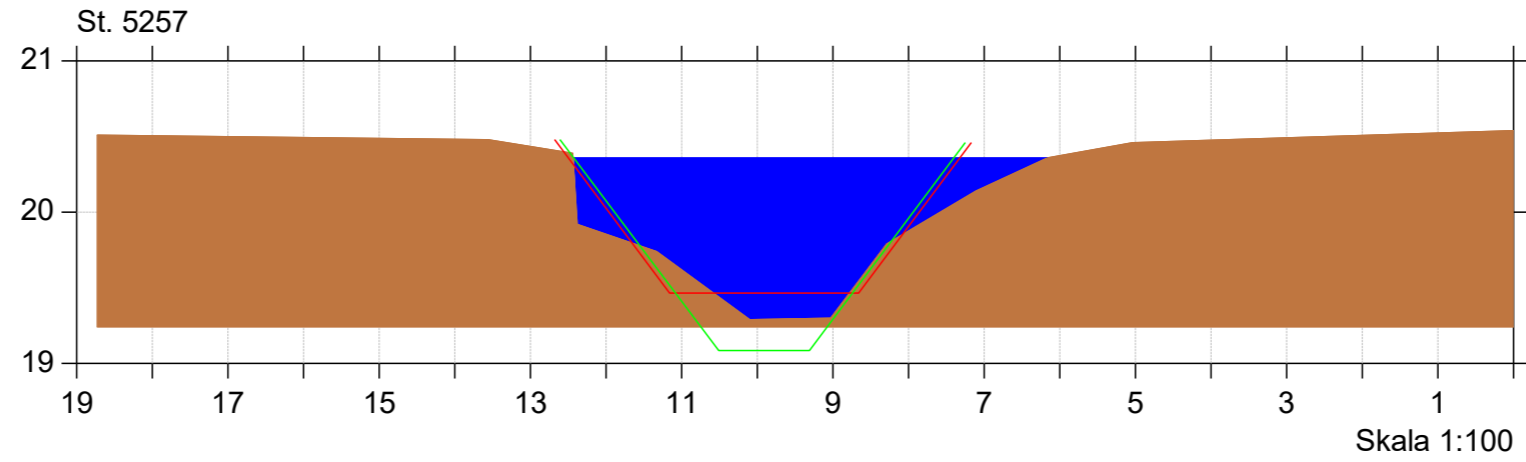
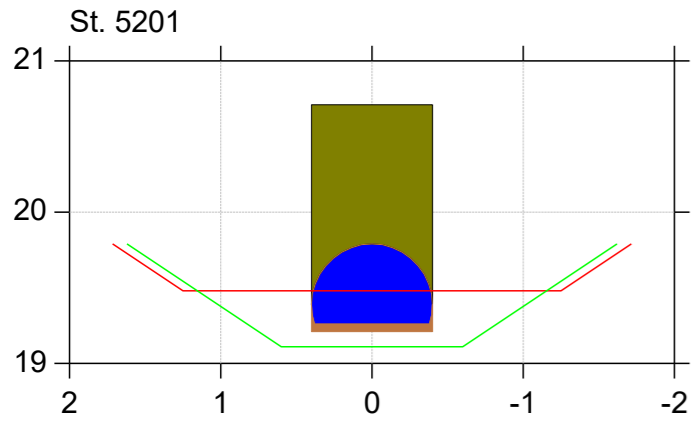

Almstrup Bæk

Regulativrevision

Lodret akse : Kote i m DVR90, skala 1:50

Vandret akse : Afstand i m, skala 1:50



Bilag 4.1

- Tidligere regulativ
- Regulativ
- Opmålt profil

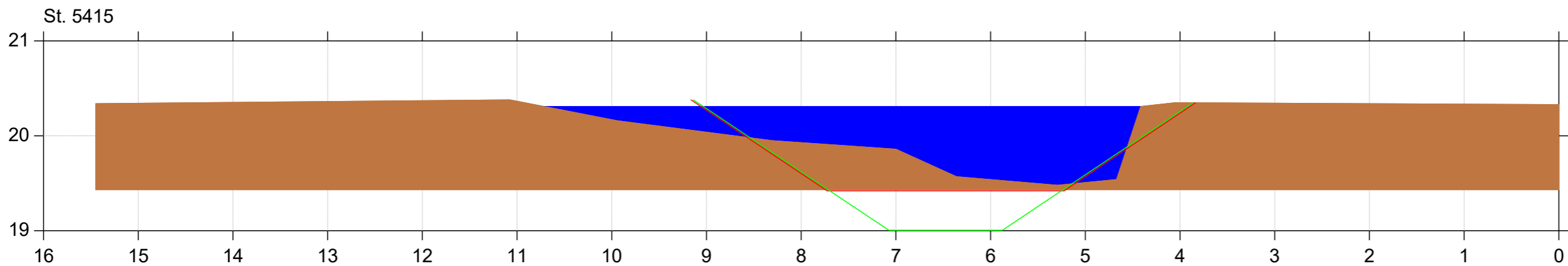
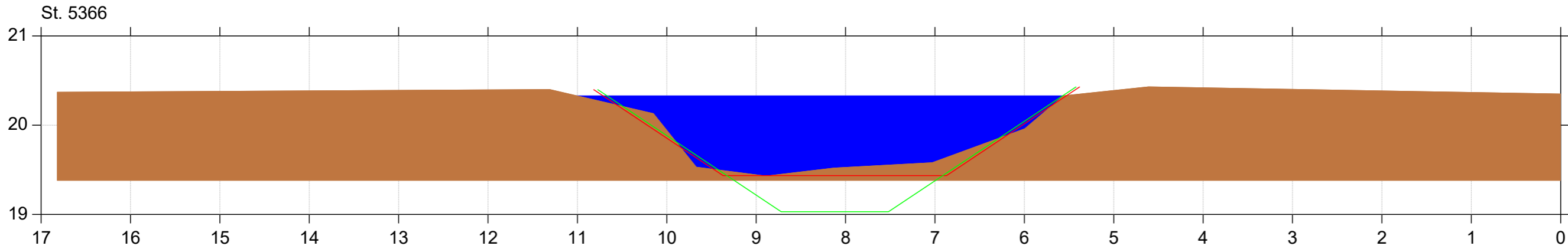

Almstrup Bæk

Regulativrevision

Lodret akse : Kote i m DVR90, skala 1:50

Vandret akse : Afstand i m, skala 1:50

- Tidligere regulativ
- Regulativ
- Opmålt profil



Bilag 4.1

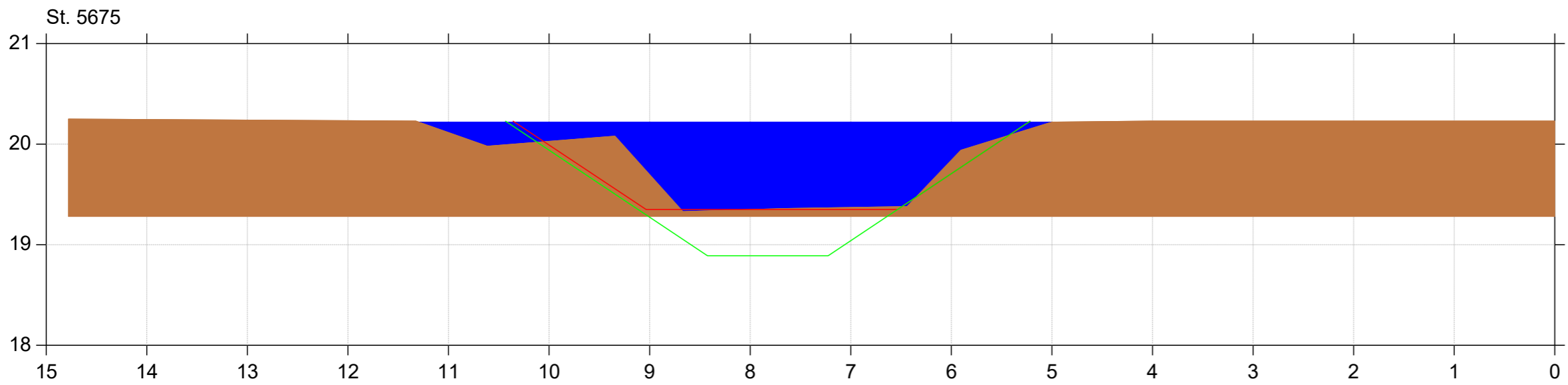
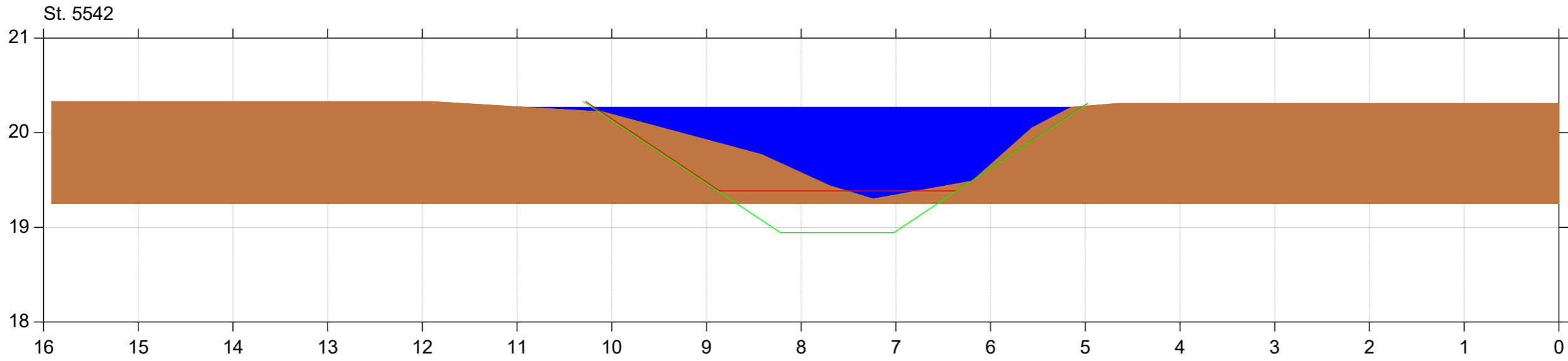

Almstrup Bæk

Regulativrevision

Lodret akse : Kote i m DVR90, skala 1:50

Vandret akse : Afstand i m, skala 1:50

- Tidligere regulativ
- Regulativ
- Opmålt profil



Bilag 4.1

St. 5725

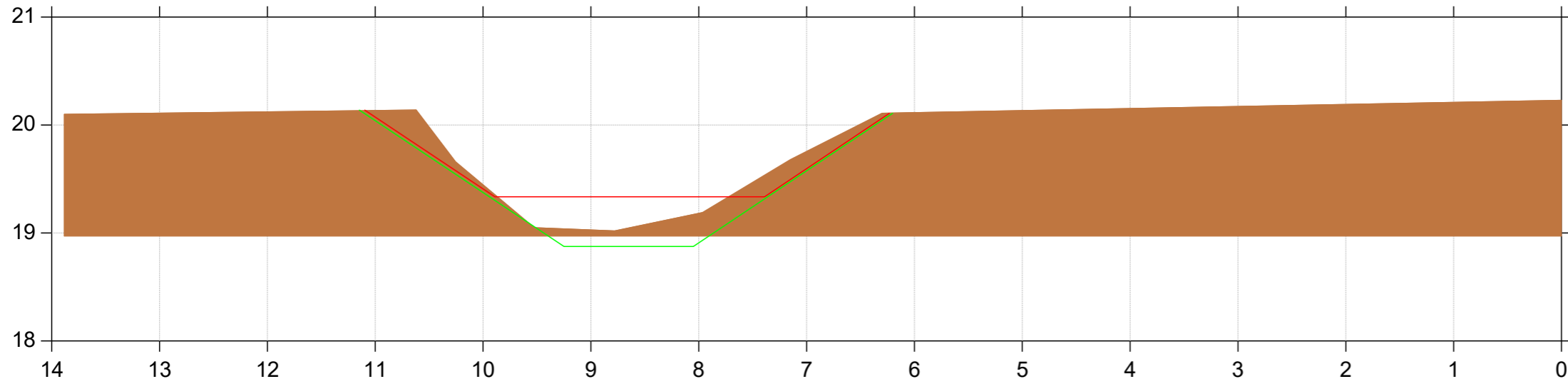

St. 5873

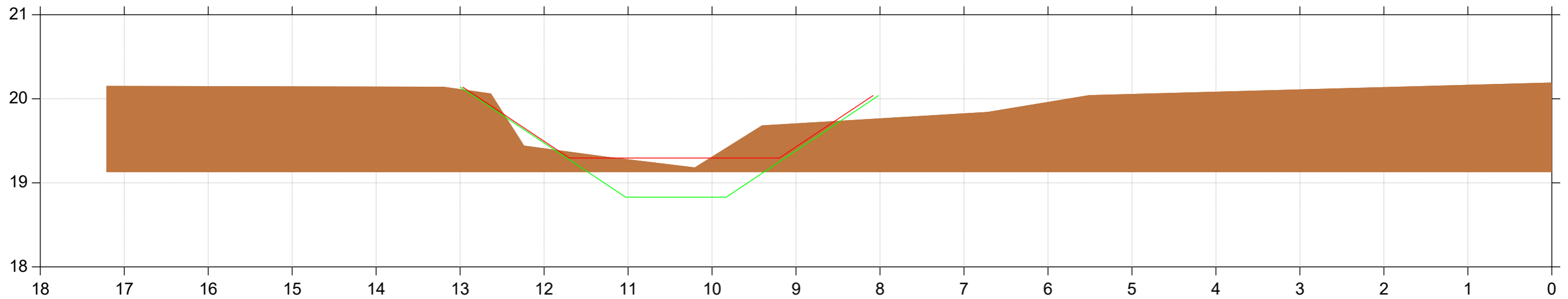

Almstrup Bæk

Regulativrevision

Lodret akse : Kote i m DVR90, skala 1:50

Vandret akse : Afstand i m, skala 1:50

- Tidligere regulativ
- Regulativ
- Opmålt profil



Bilag 4.1

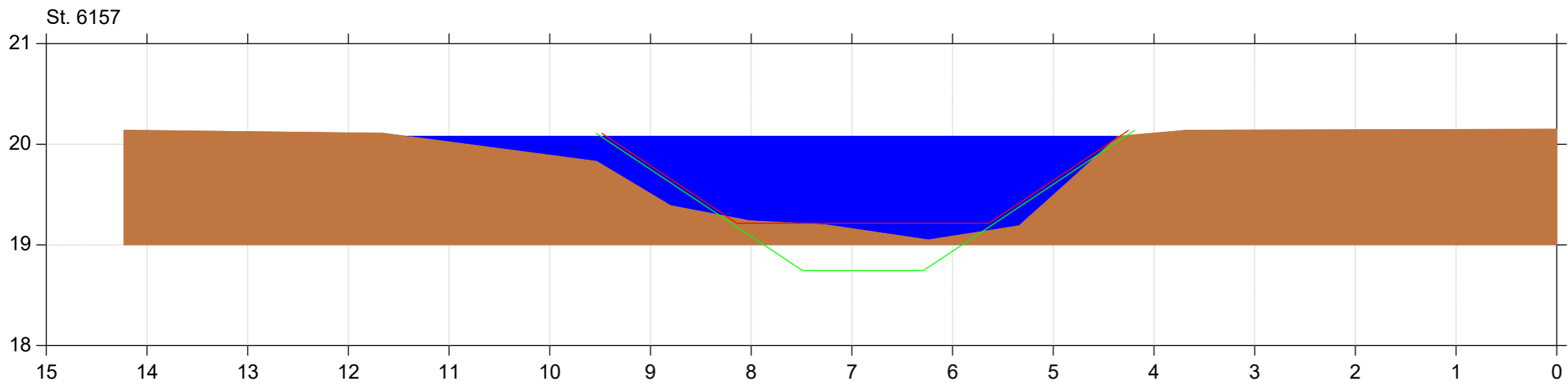
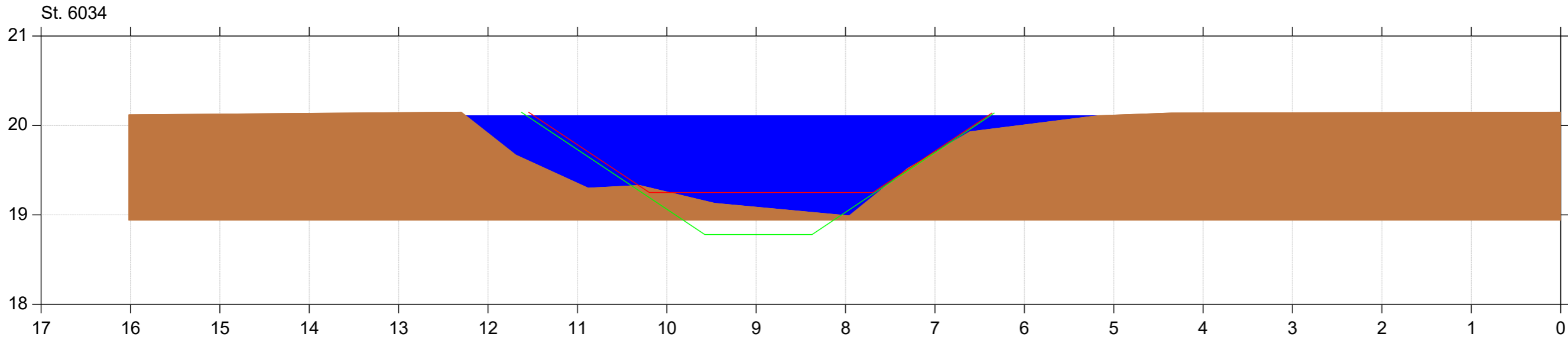

Almstrup Bæk

Regulativrevision

Lodret akse : Kote i m DVR90, skala 1:50

Vandret akse : Afstand i m, skala 1:50

- Tidligere regulativ
- Regulativ
- Opmålt profil



Bilag 4.1

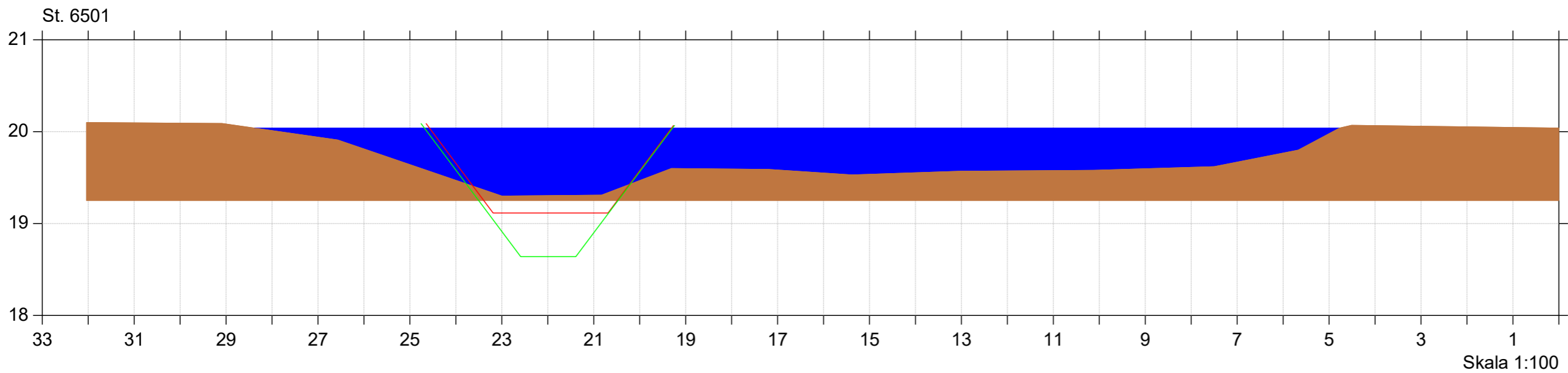
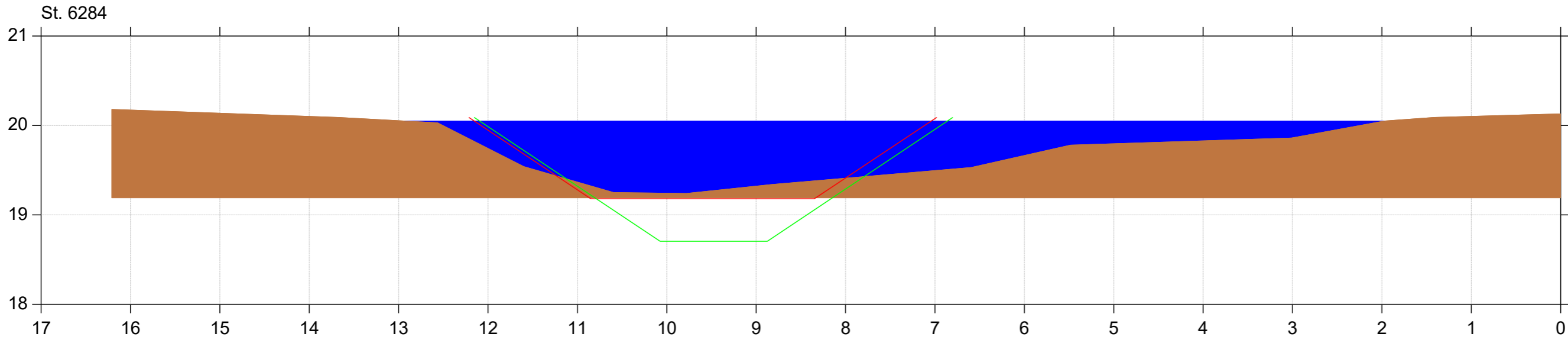

Almstrup Bæk

Regulativrevision

Lodret akse : Kote i m DVR90, skala 1:50

Vandret akse : Afstand i m, skala 1:50

- Tidligere regulativ
- Regulativ
- Opmålt profil



Bilag 4.1

St. 6627

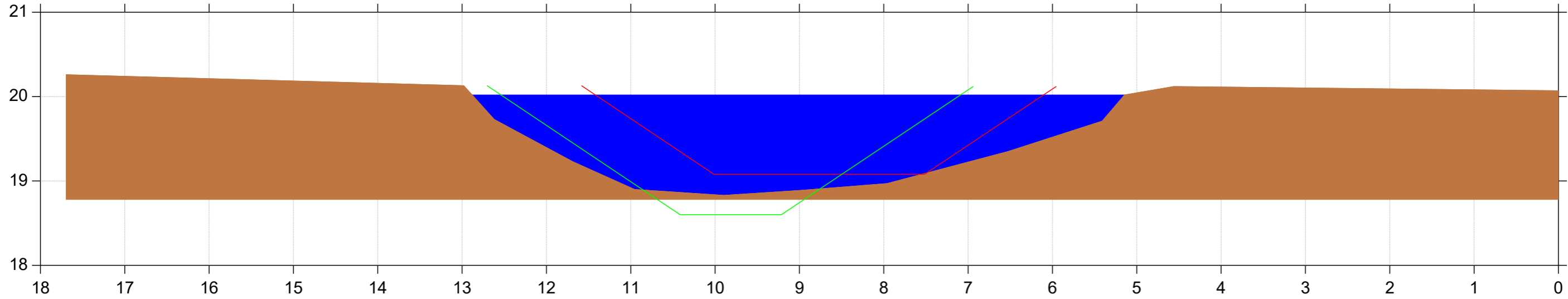

St. 6634

