

Almstrup Bæk

Regulativrevision

Lodret akse : Kote i m DVR90, skala 1:50

Vandret akse : Afstand i m, skala 1:50

- Tidligere regulativ
- Regulativ 2025
- Bund opmålt (2020/2024)

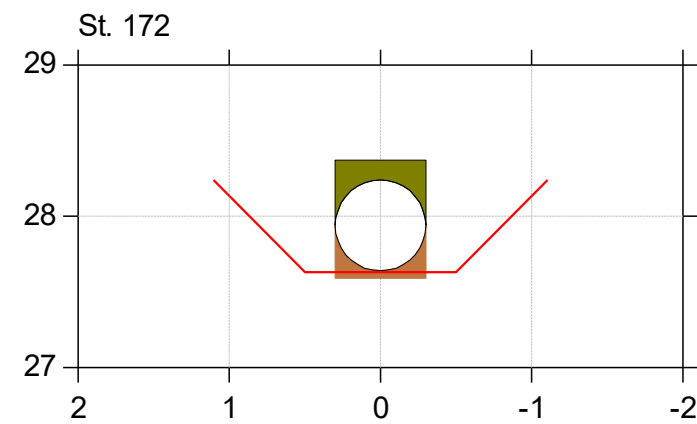
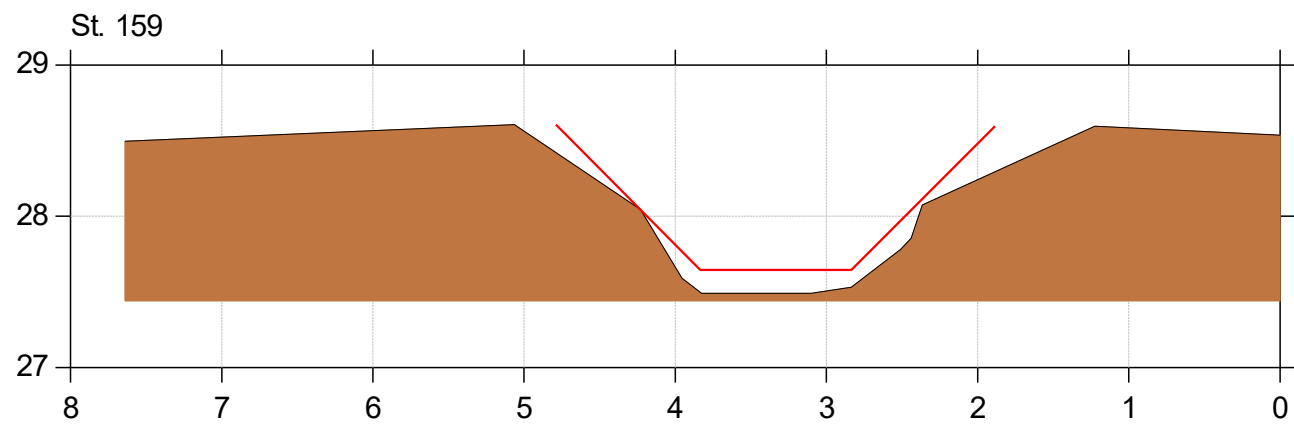
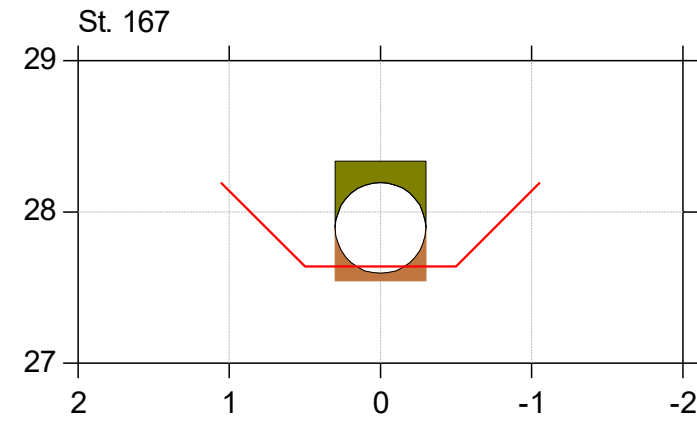
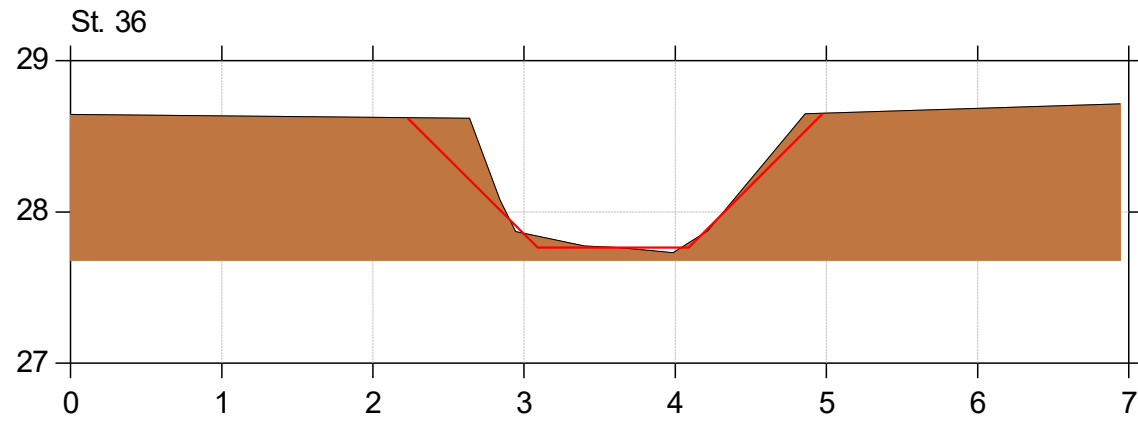

Almstrup Bæk

Regulativrevision

Lodret akse : Kote i m DVR90, skala 1:50

Vandret akse : Afstand i m, skala 1:50

- Tidligere regulativ
- Regulativ 2025
- Bund opmålt (2020/2024)

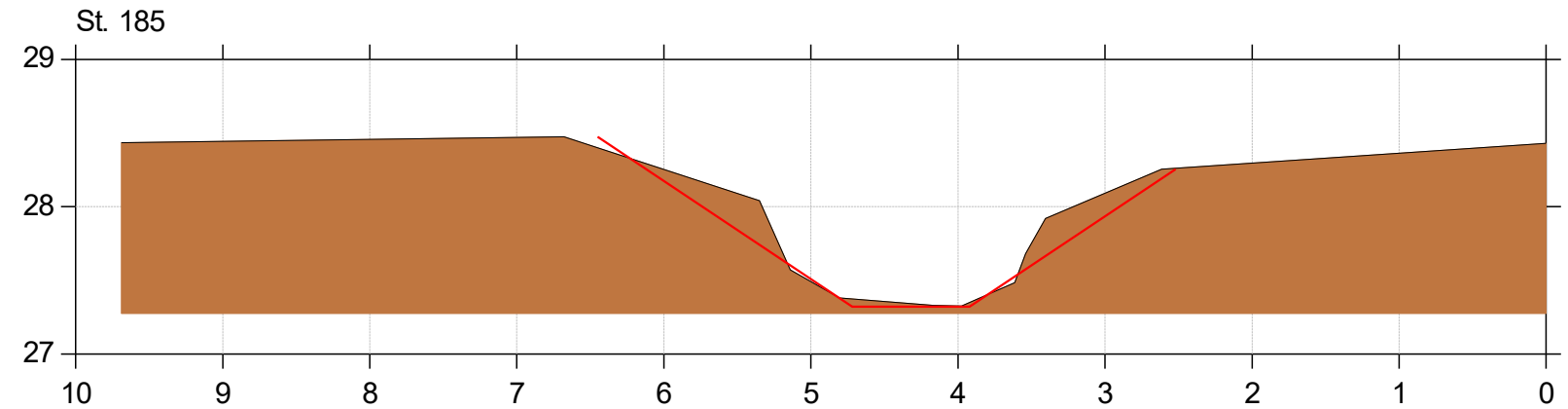
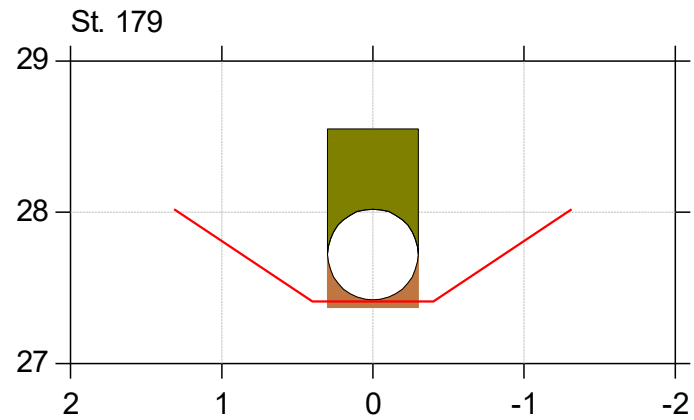
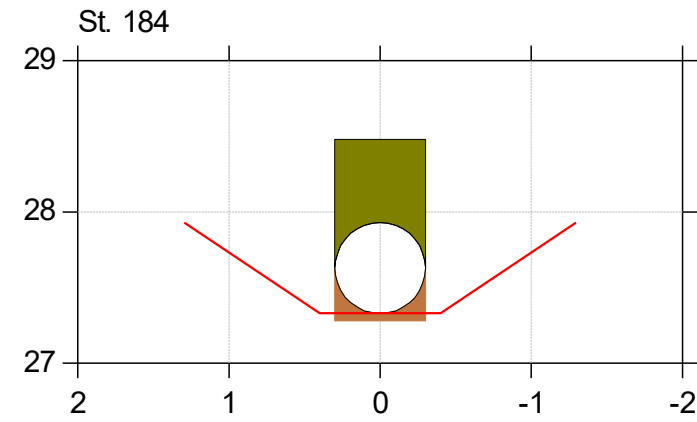
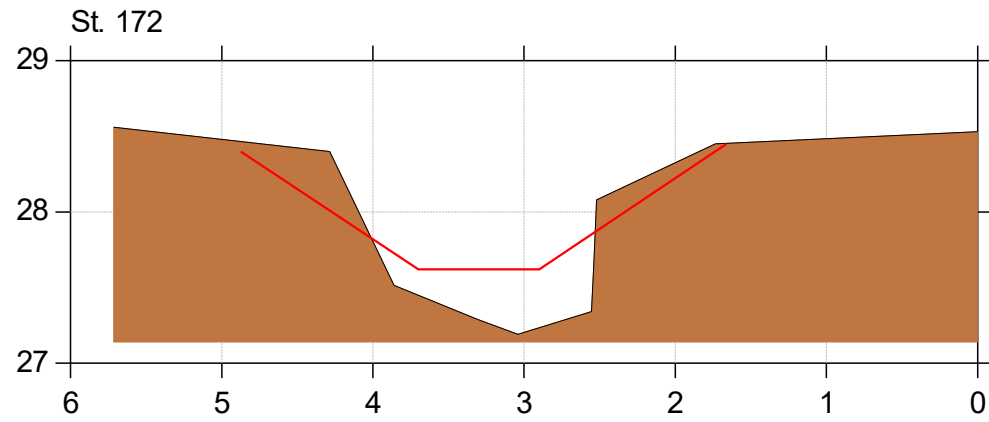

Almstrup Bæk

Regulativrevision

Lodret akse : Kote i m DVR90, skala 1:50

Vandret akse : Afstand i m, skala 1:50

- Tidligere regulativ
- Regulativ 2025
- Bund opmålt (2020/2024)

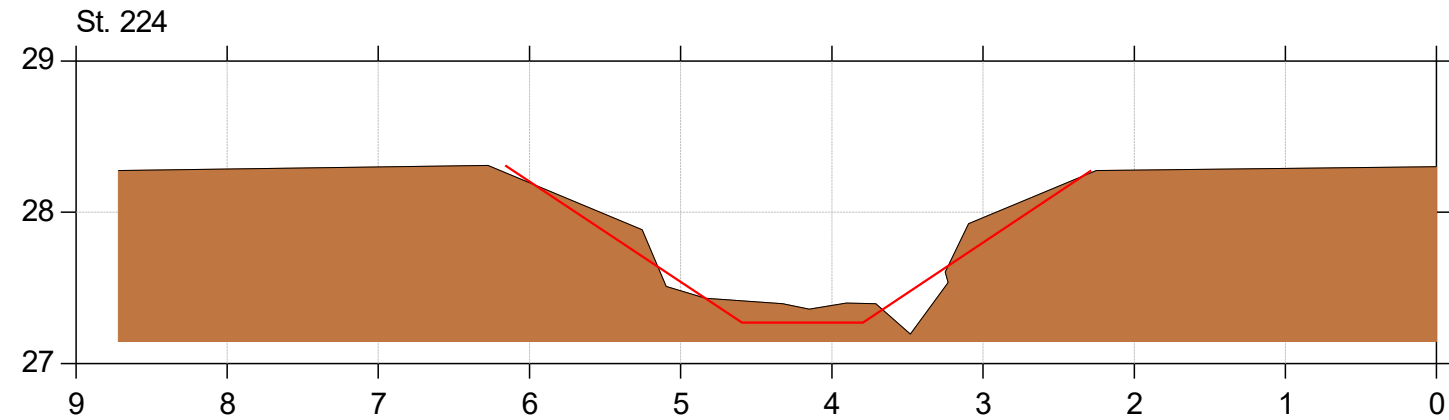
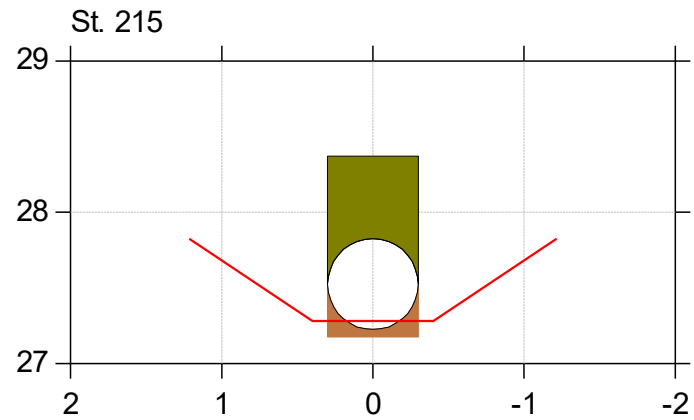
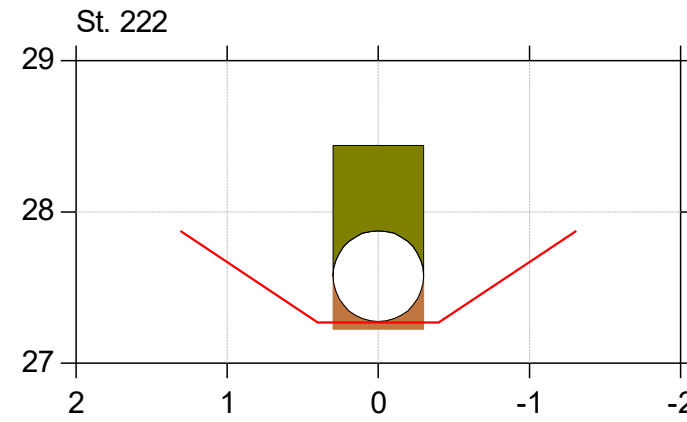
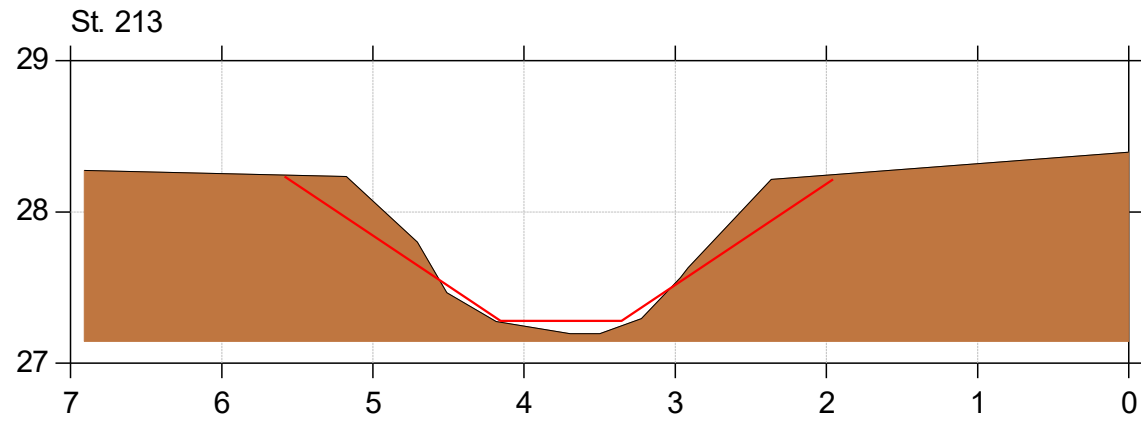

Almstrup Bæk

Regulativrevision

Lodret akse : Kote i m DVR90, skala 1:50

Vandret akse : Afstand i m, skala 1:50

- Tidligere regulativ
- Regulativ 2025
- Bund opmålt (2020/2024)

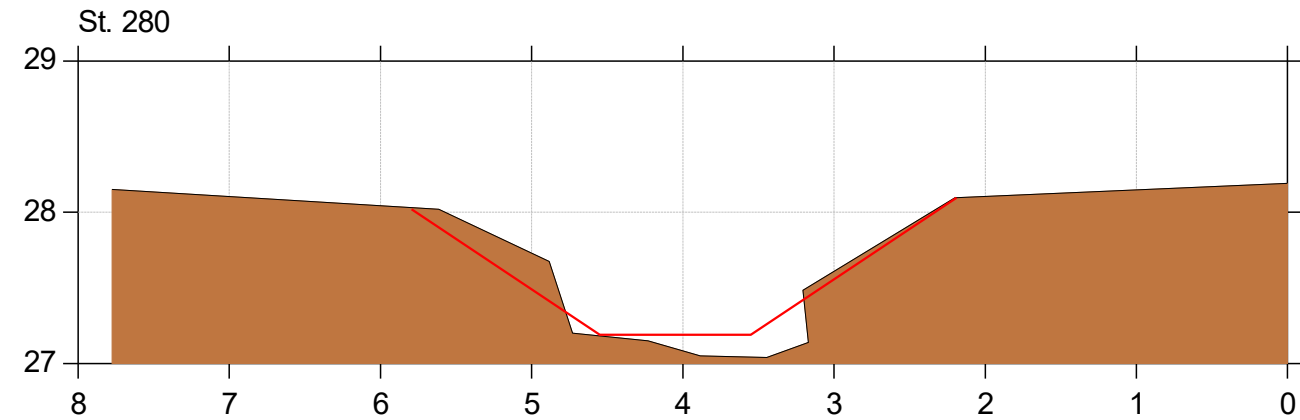
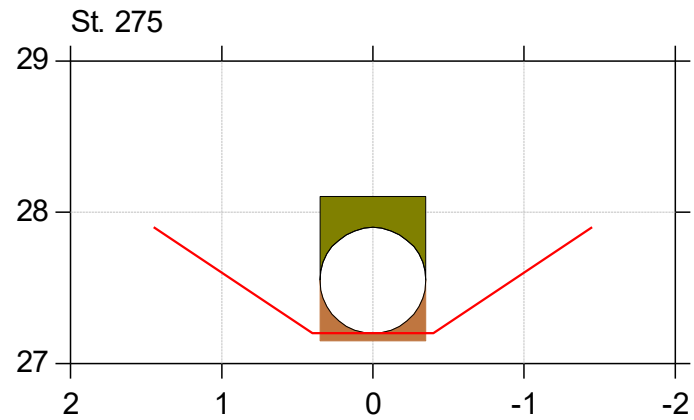
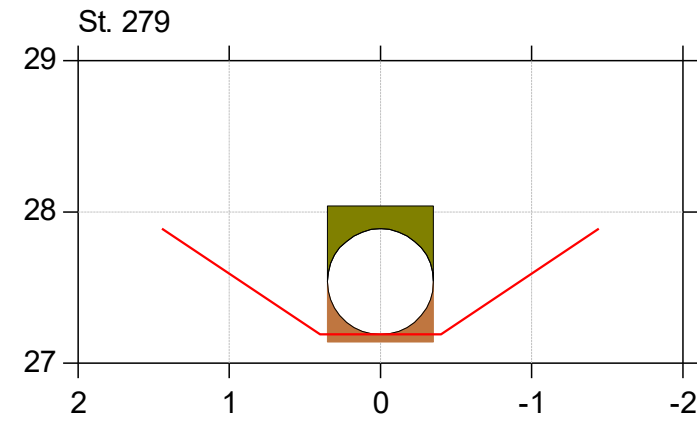
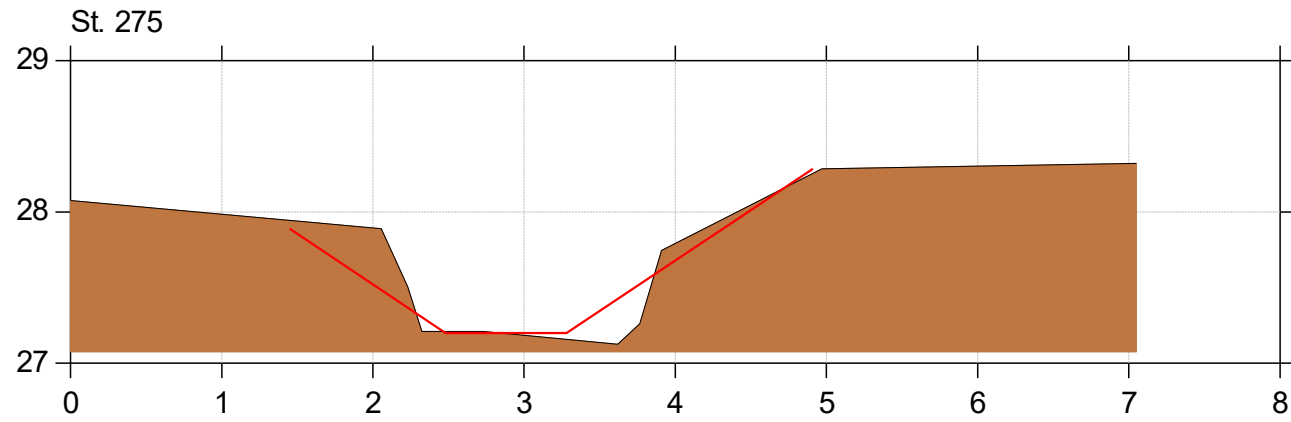

Almstrup Bæk

Regulativrevision

Lodret akse : Kote i m DVR90, skala 1:50

Vandret akse : Afstand i m, skala 1:50

- Tidligere regulativ
- Regulativ 2025
- Bund opmålt (2020/2024)

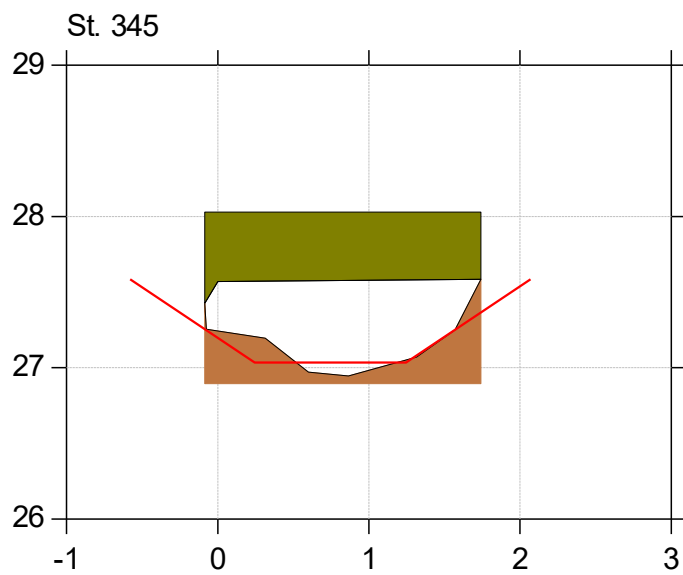
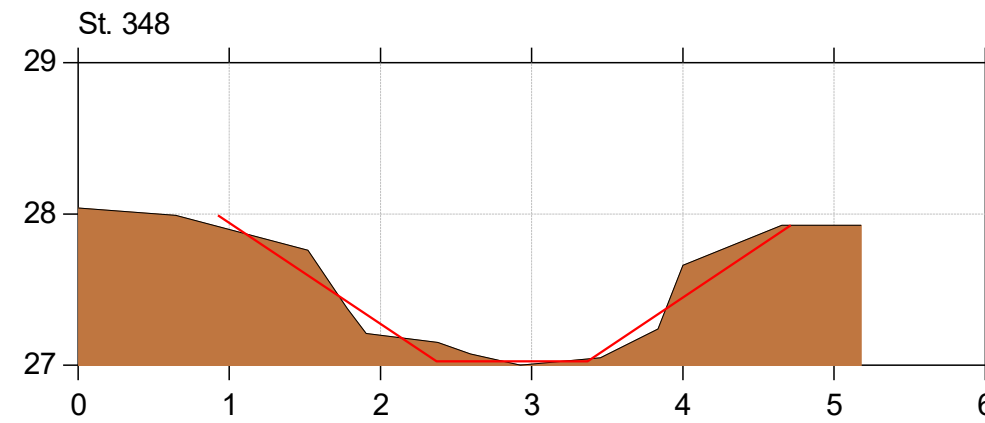
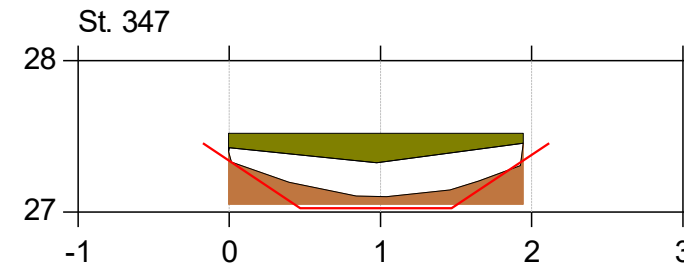
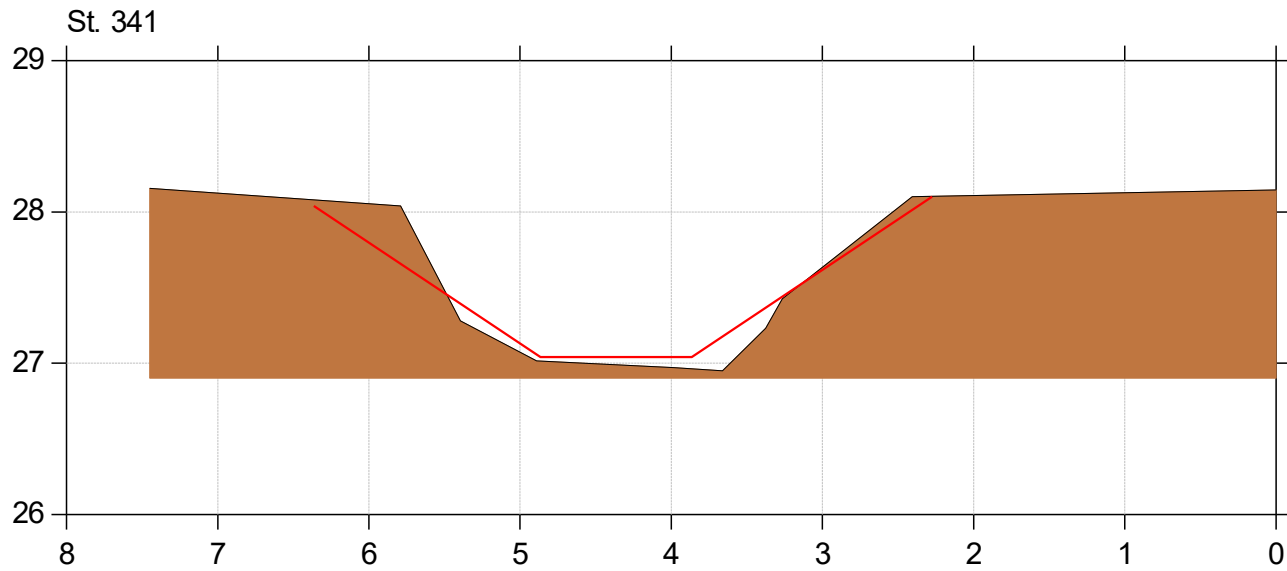

Almstrup Bæk

Regulativrevision

Lodret akse : Kote i m DVR90, skala 1:50

Vandret akse : Afstand i m, skala 1:50

- Tidligere regulativ
- Regulativ 2025
- Bund opmålt (2020/2024)

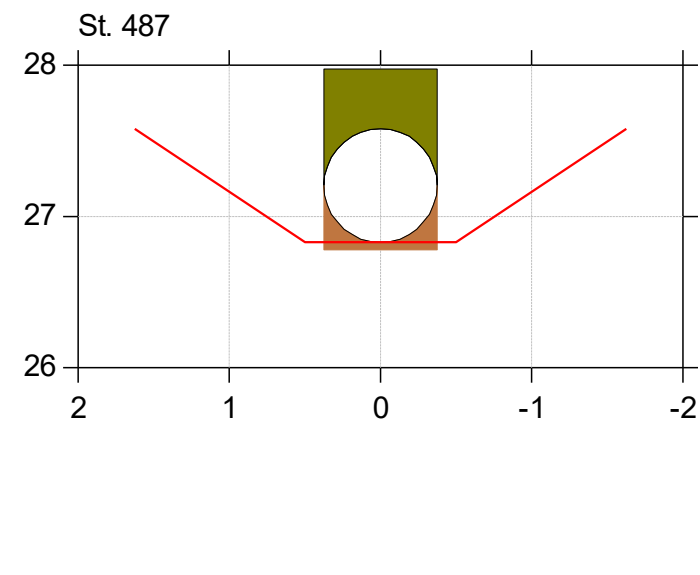
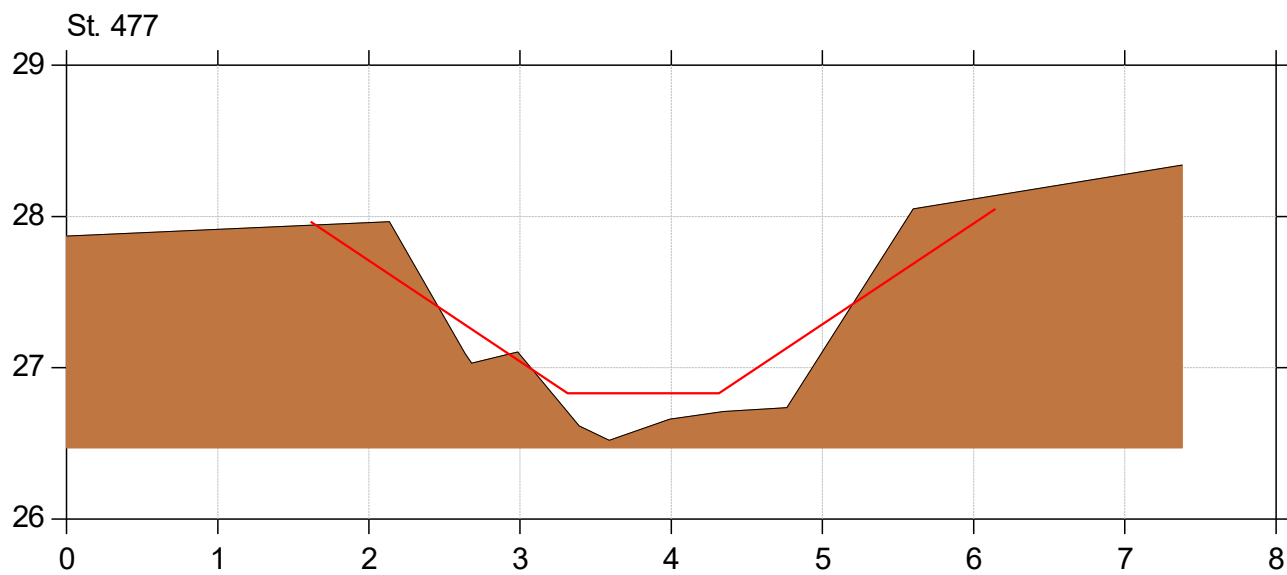
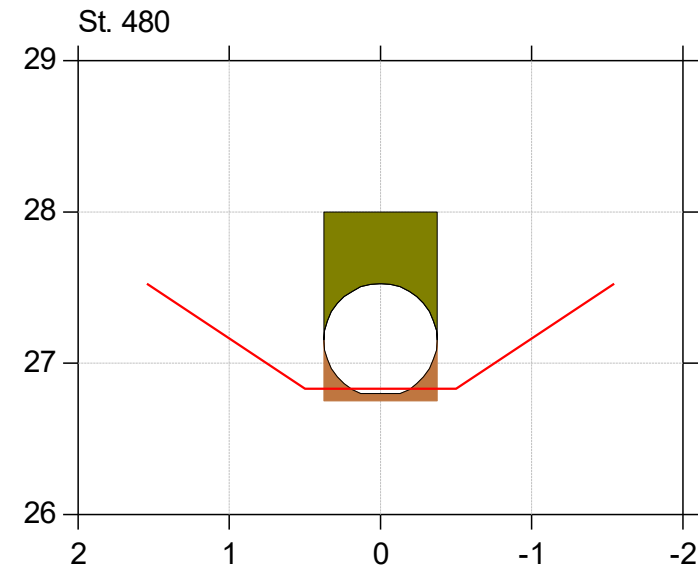
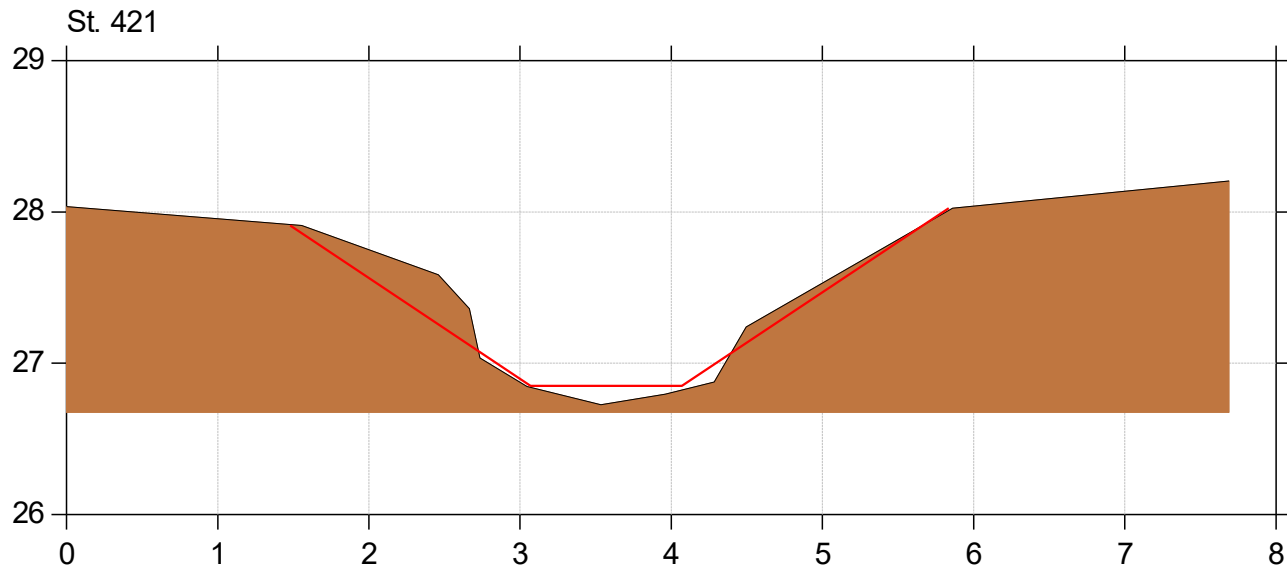

Almstrup Bæk

Regulativrevision

Lodret akse : Kote i m DVR90, skala 1:50

Vandret akse : Afstand i m, skala 1:50

- Tidligere regulativ
- Regulativ 2025
- Bund opmålt (2020/2024)

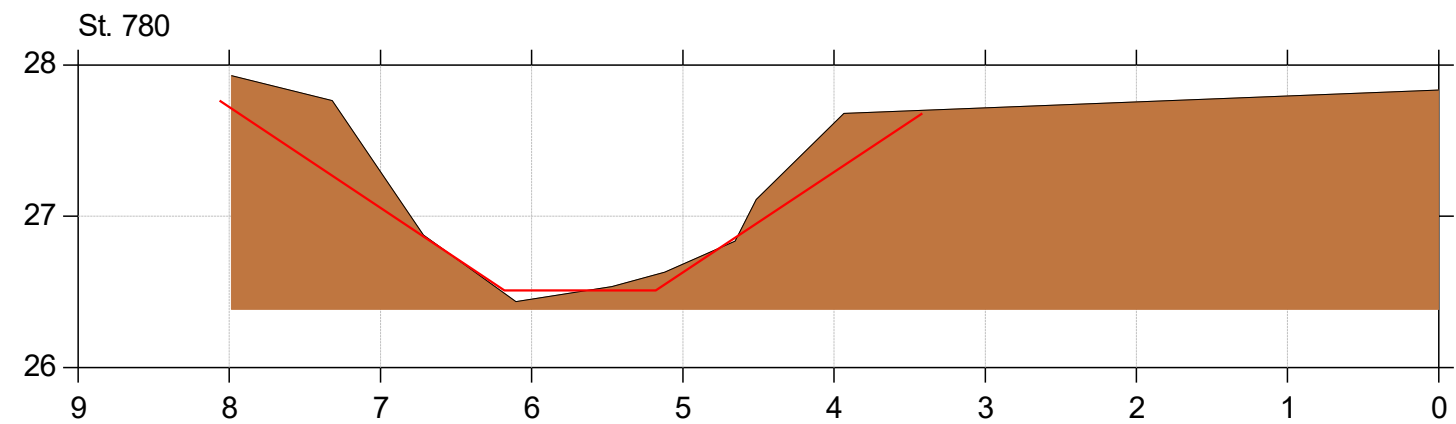
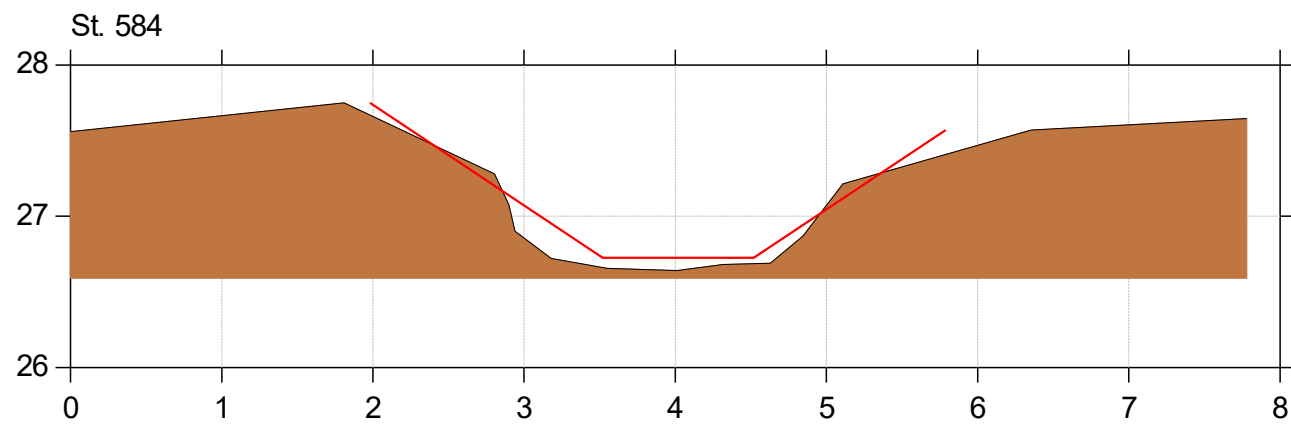
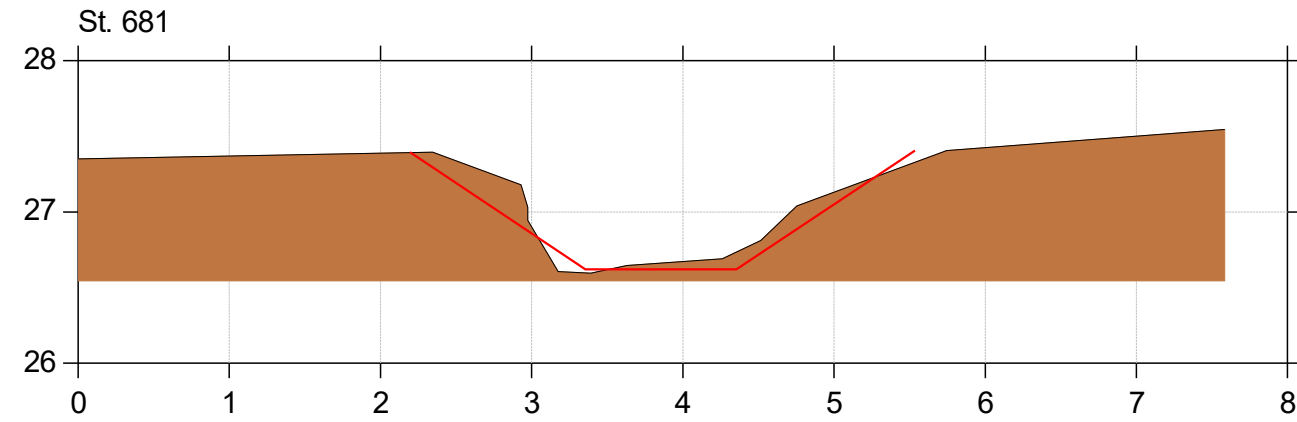
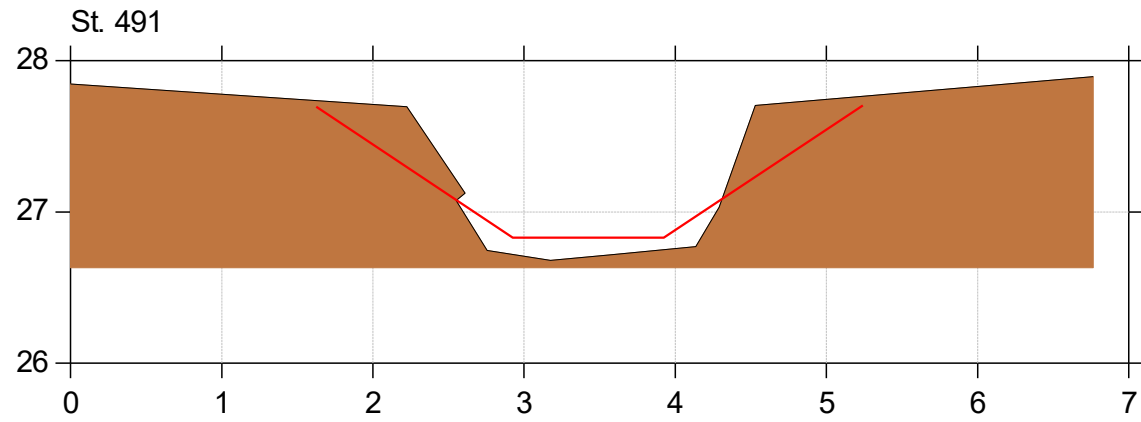

Almstrup Bæk

Regulativrevision

Lodret akse : Kote i m DVR90, skala 1:50

Vandret akse : Afstand i m, skala 1:50

- Tidligere regulativ
- Regulativ 2025
- Bund opmålt (2020/2024)

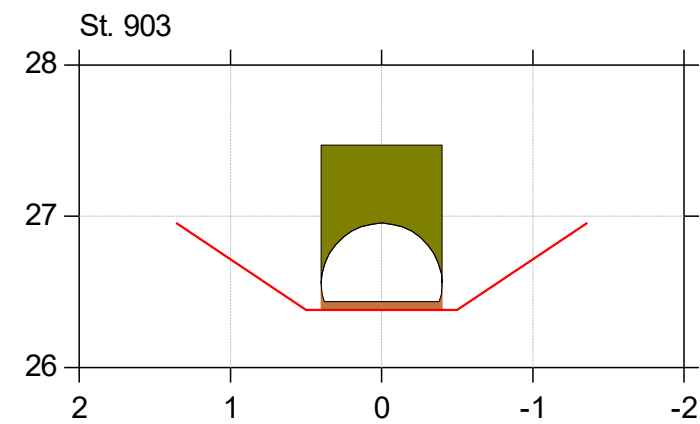
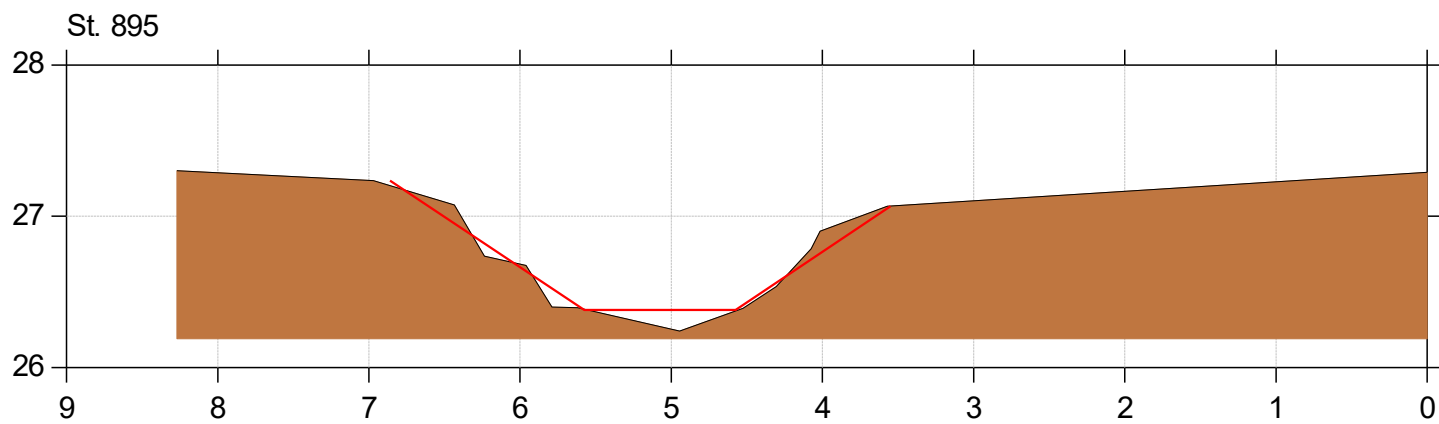
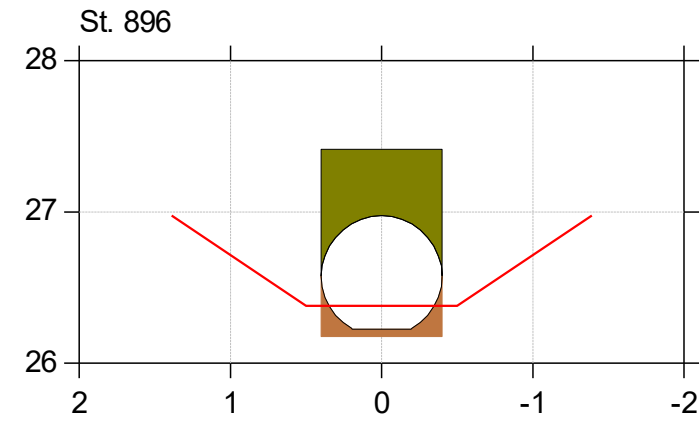
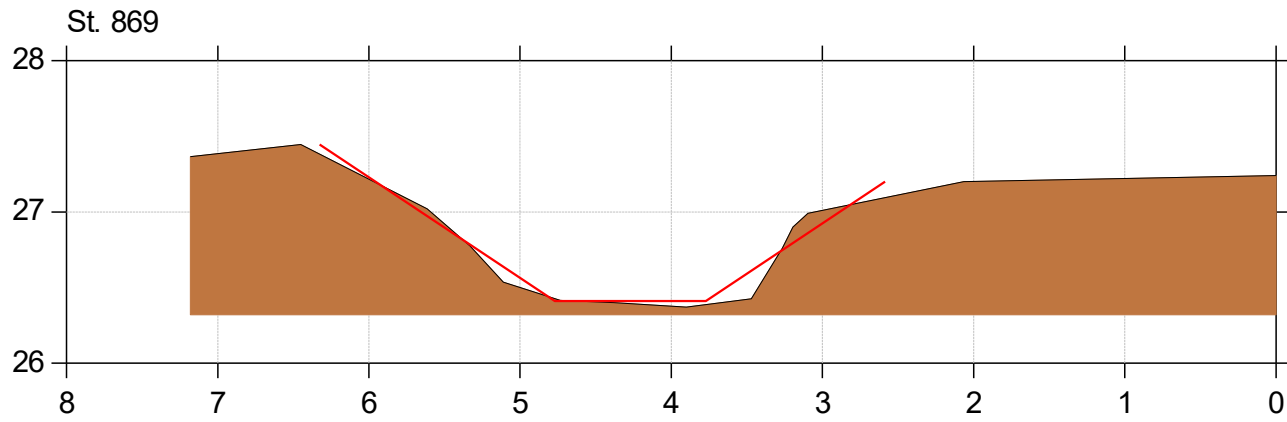

Almstrup Bæk

Regulativrevision

Lodret akse : Kote i m DVR90, skala 1:50

Vandret akse : Afstand i m, skala 1:50

- Tidligere regulativ
- Regulativ 2025
- Bund opmålt (2020/2024)

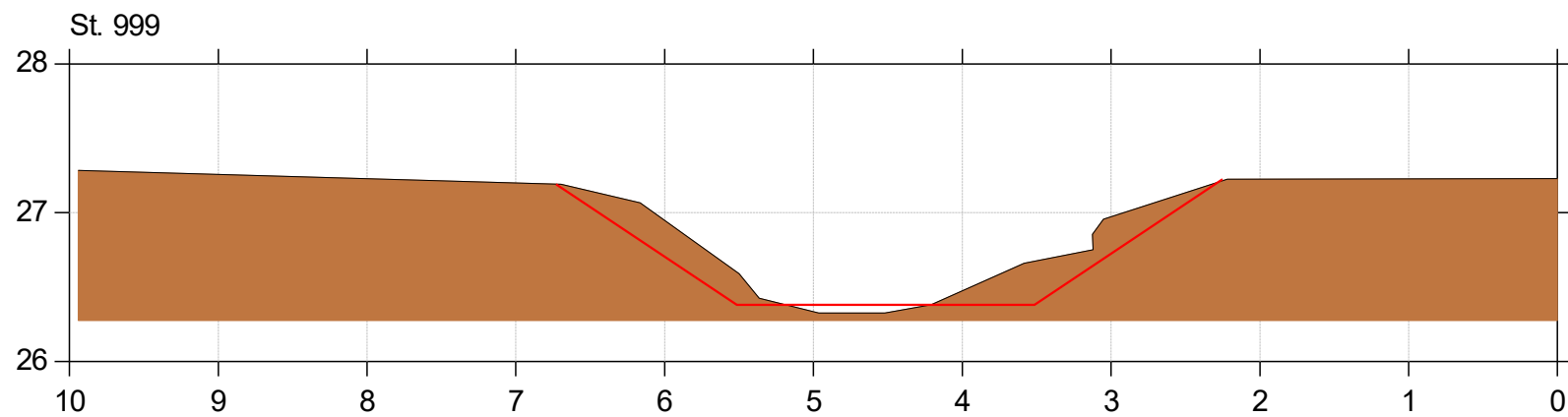
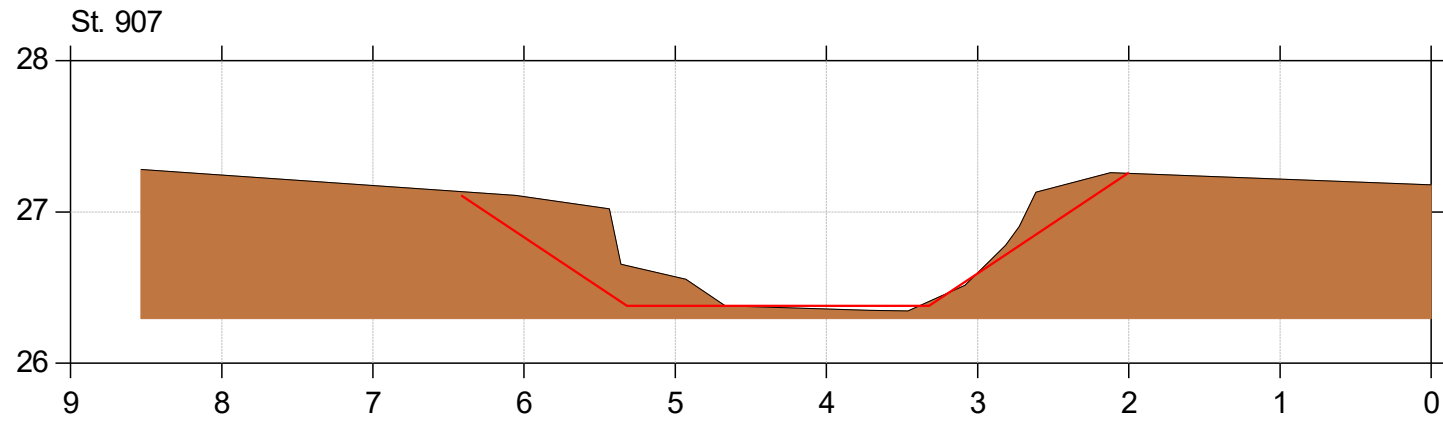

Almstrup Bæk

Regulativrevision

Lodret akse : Kote i m DVR90, skala 1:50

Vandret akse : Afstand i m, skala 1:50

- Tidligere regulativ
- Regulativ 2025
- Bund opmålt (2020/2024)

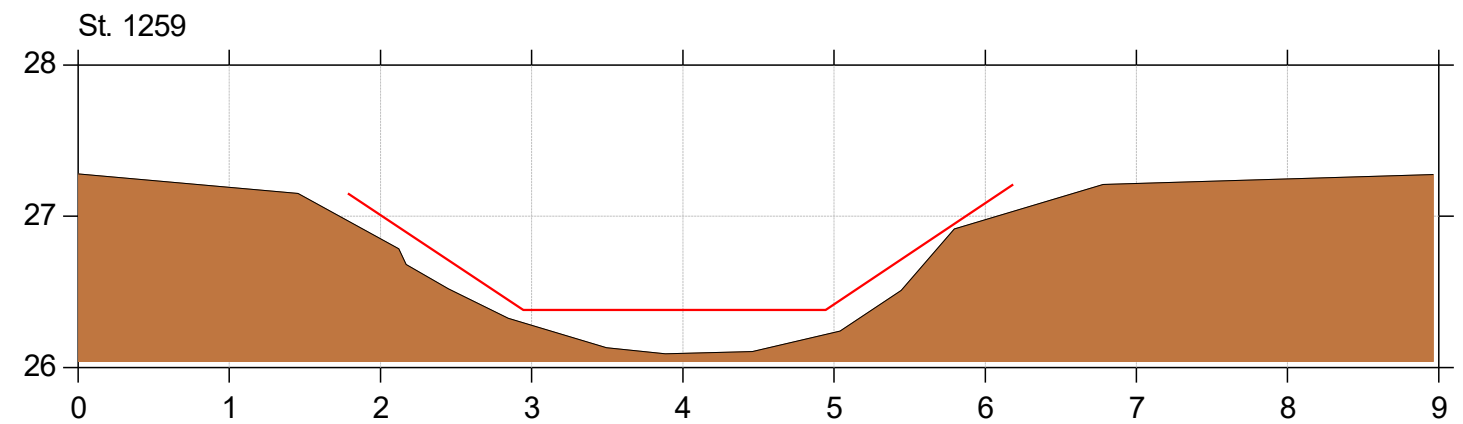
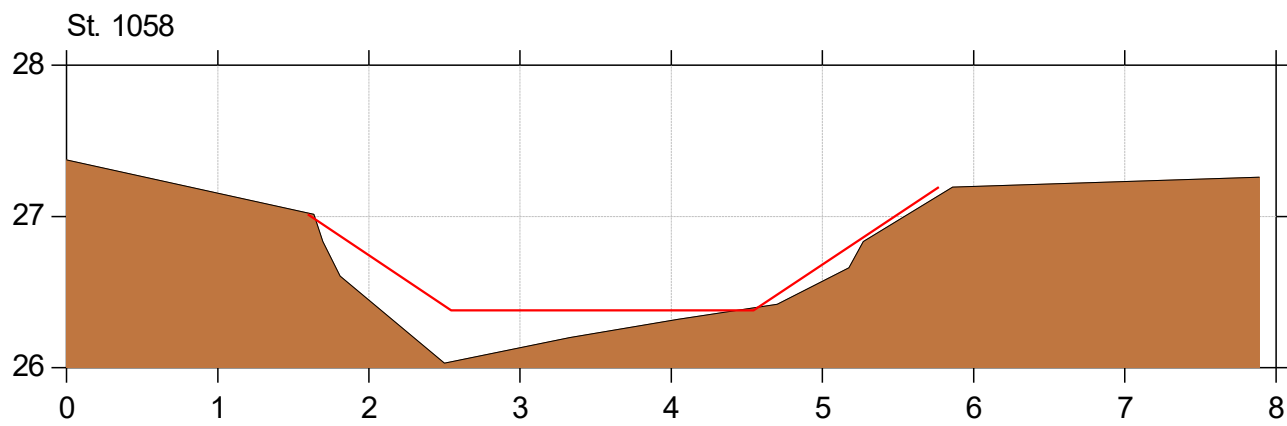
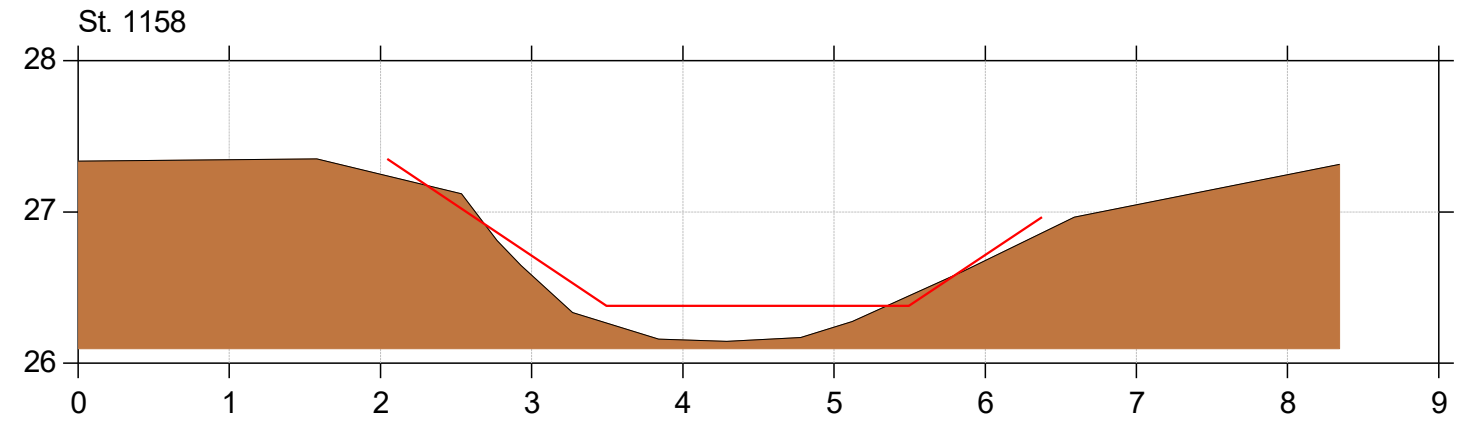
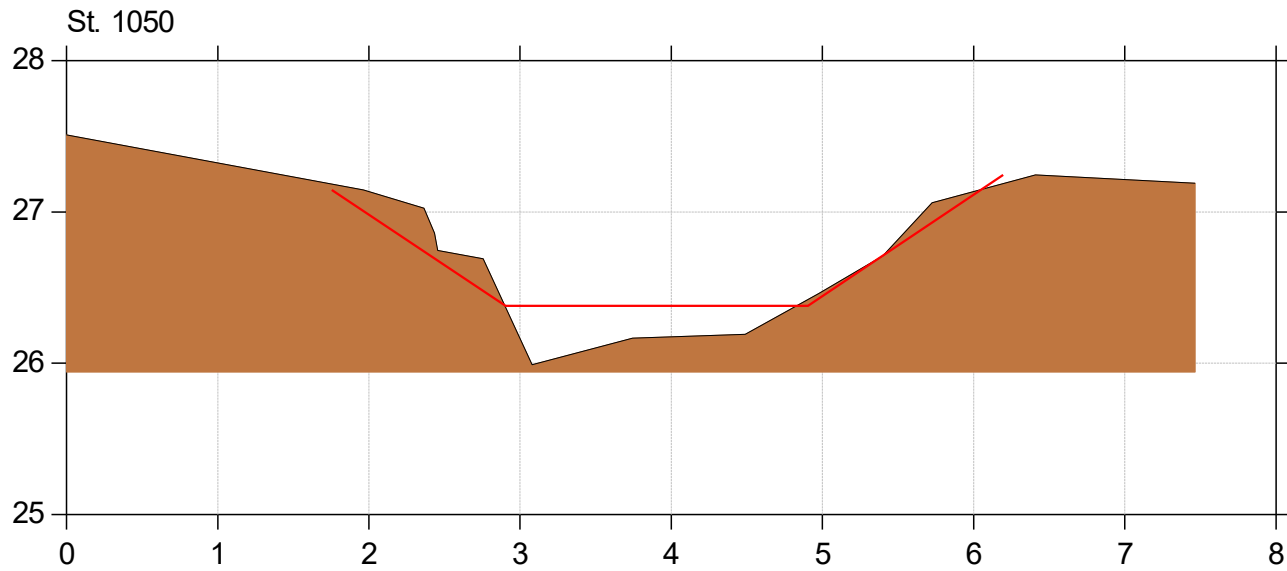

Almstrup Bæk

Regulativrevision

Lodret akse : Kote i m DVR90, skala 1:50

Vandret akse : Afstand i m, skala 1:50

- Tidligere regulativ
- Regulativ 2025
- Bund opmålt (2020/2024)

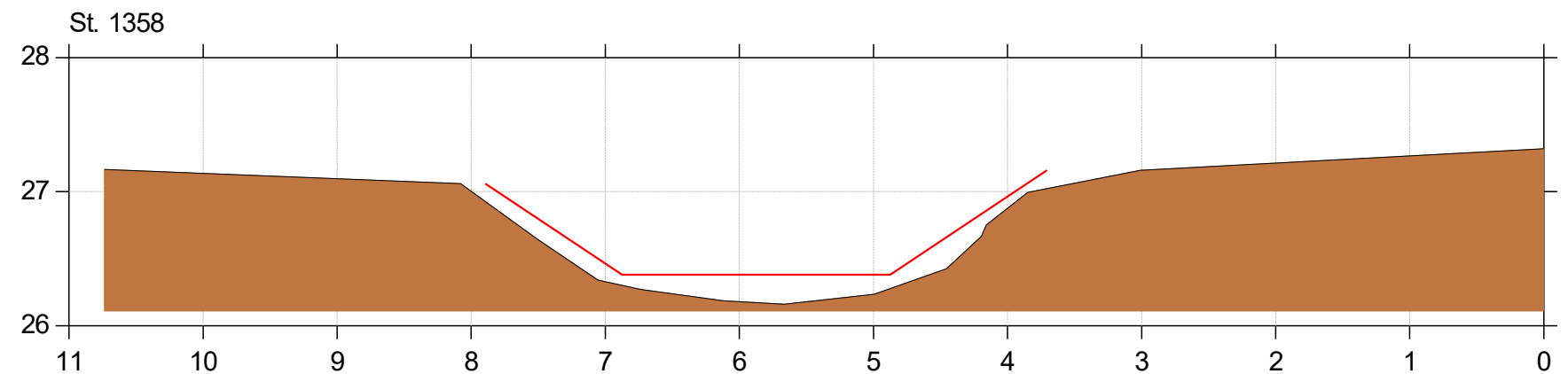
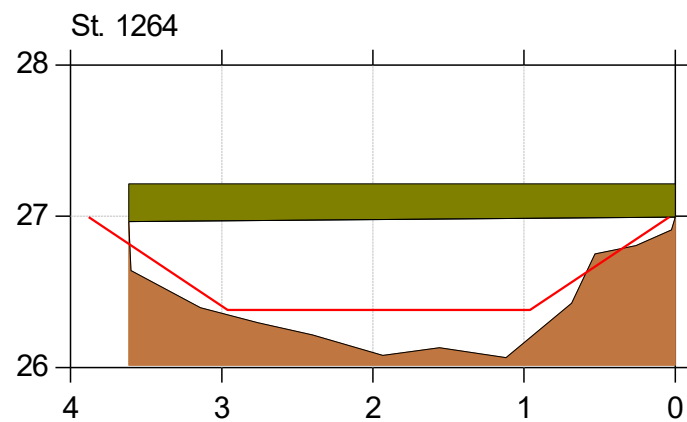
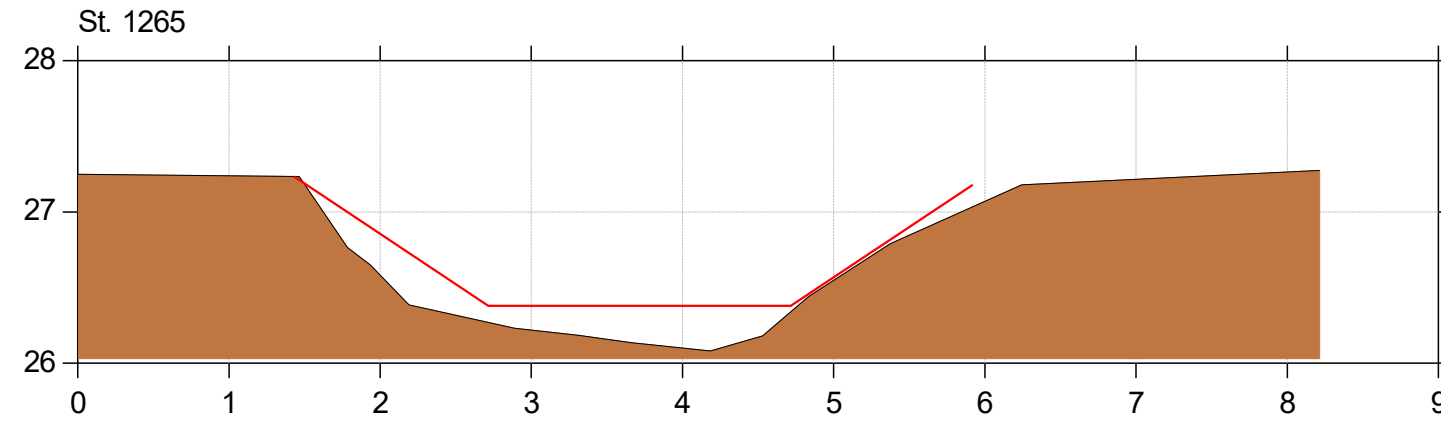
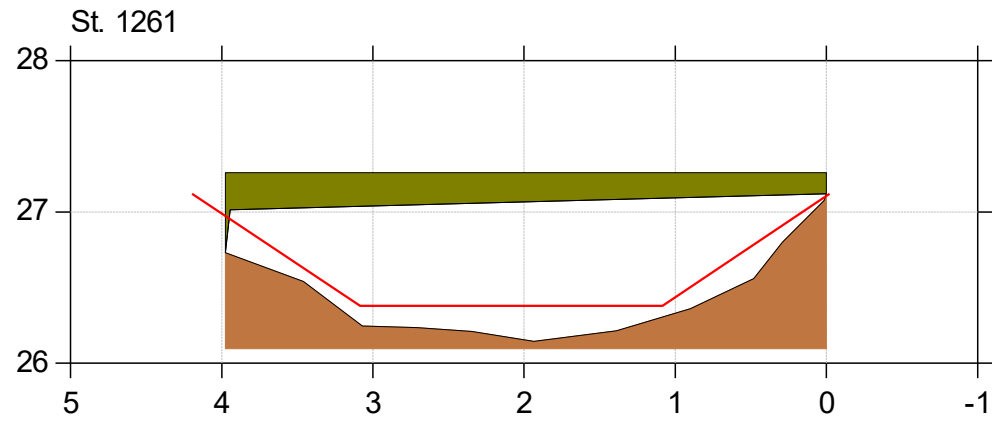

Almstrup Bæk

Regulativrevision

Lodret akse : Kote i m DVR90, skala 1:50

Vandret akse : Afstand i m, skala 1:50

- Tidligere regulativ
- Regulativ 2025
- Bund opmålt (2020/2024)

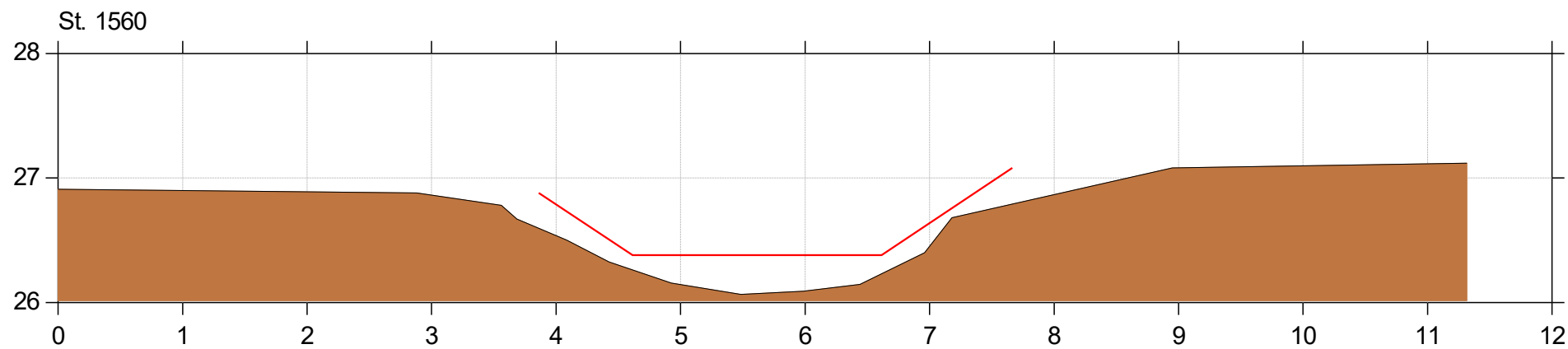
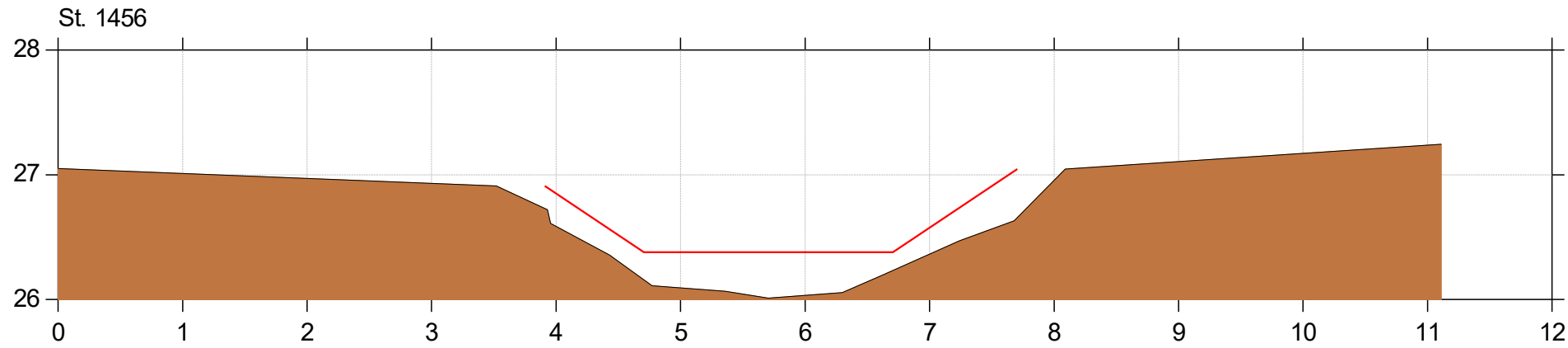

Almstrup Bæk

Regulativrevision

Lodret akse : Kote i m DVR90, skala 1:50

Vandret akse : Afstand i m, skala 1:50

- Tidligere regulativ
- Regulativ 2025
- Bund opmålt (2020/2024)

St. 1574

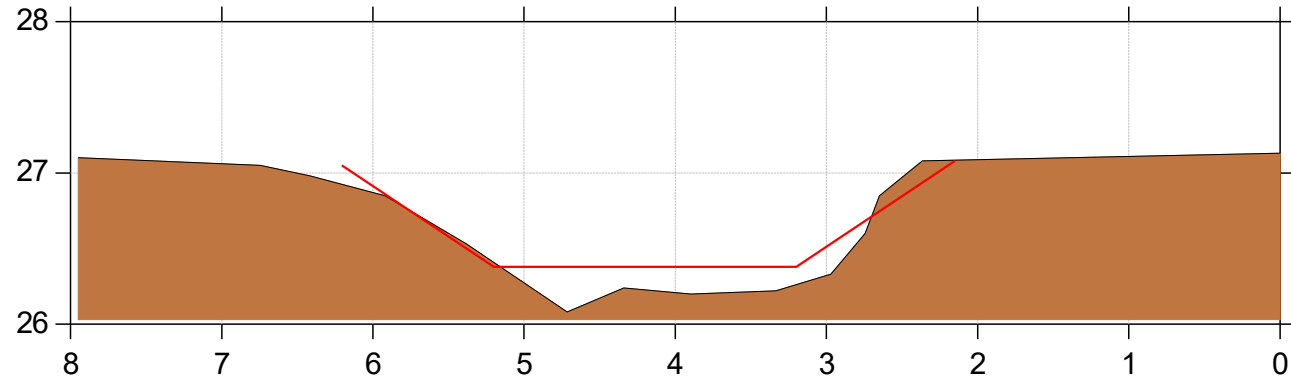

St. 1650

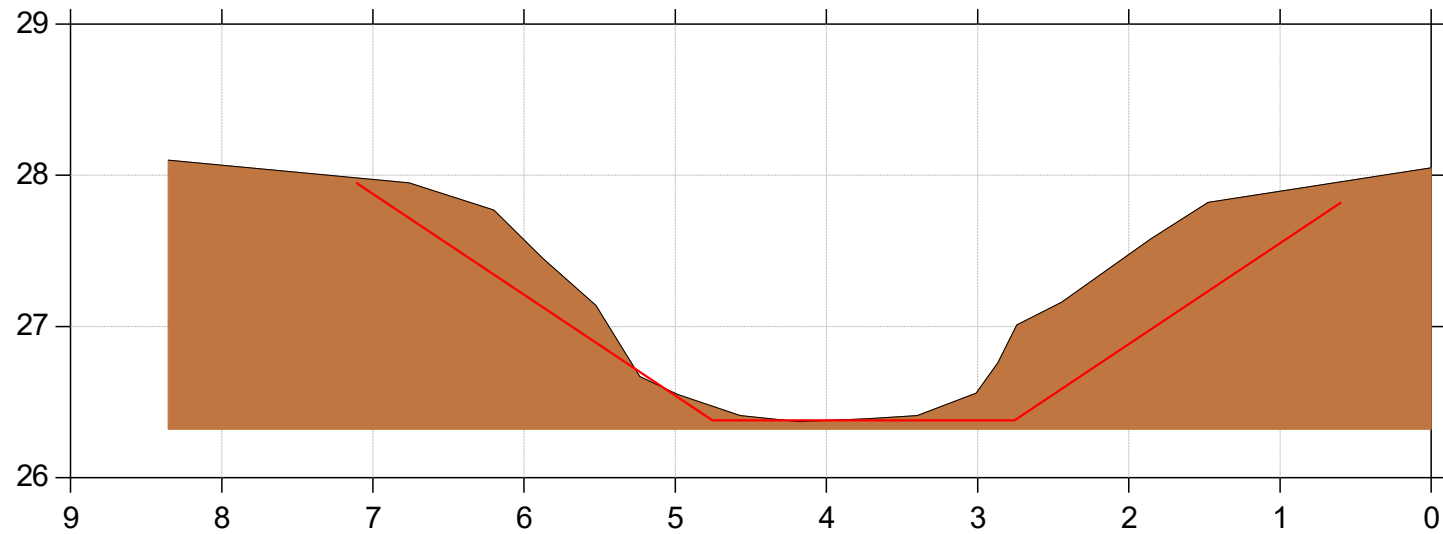

Almstrup Bæk

Regulativrevision

Lodret akse : Kote i m DVR90, skala 1:50

Vandret akse : Afstand i m, skala 1:50

- Tidligere regulativ
- Regulativ 2025
- Bund opmålt (2020/2024)

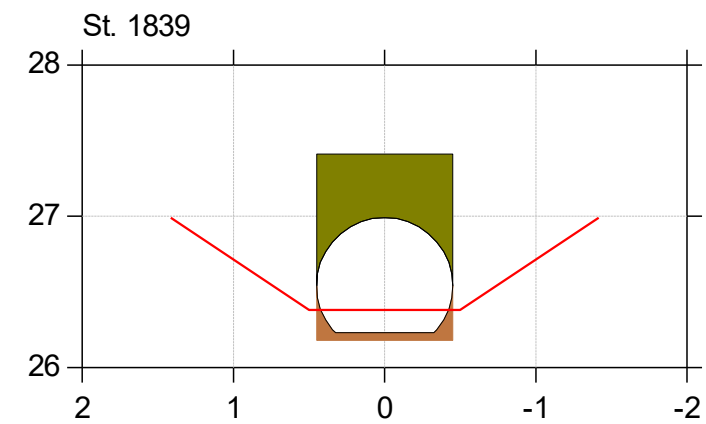
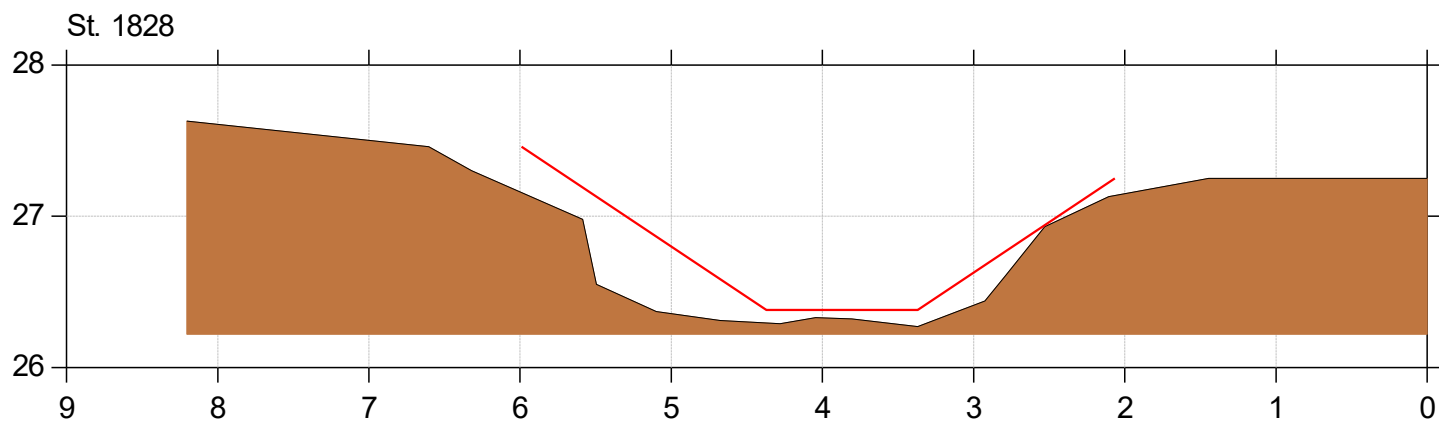
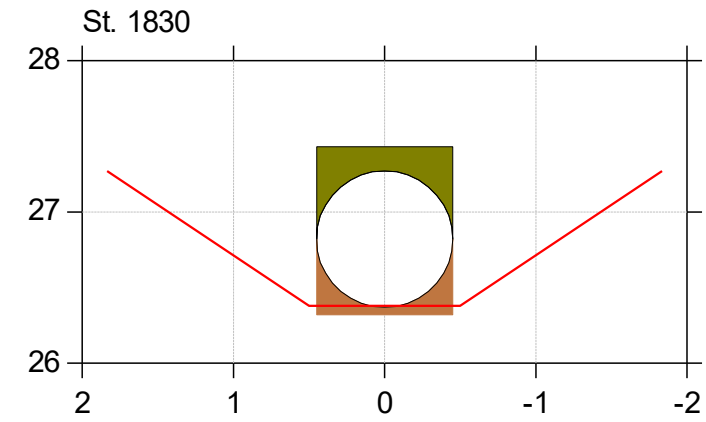
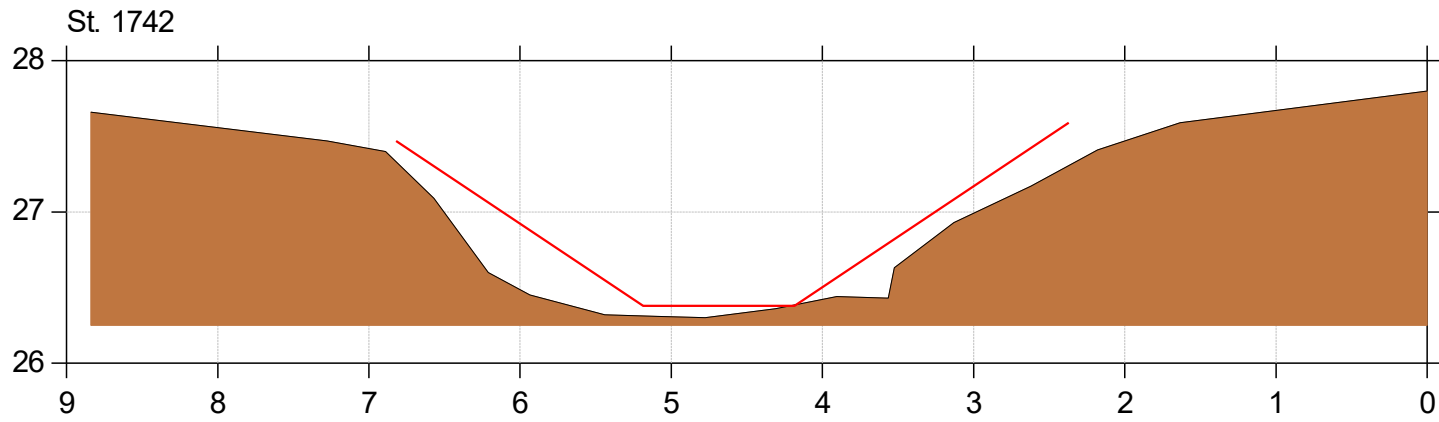

Almstrup Bæk

Regulativrevision

Lodret akse : Kote i m DVR90, skala 1:50

Vandret akse : Afstand i m, skala 1:50

- Tidligere regulativ
- Regulativ 2025
- Bund opmålt (2020/2024)

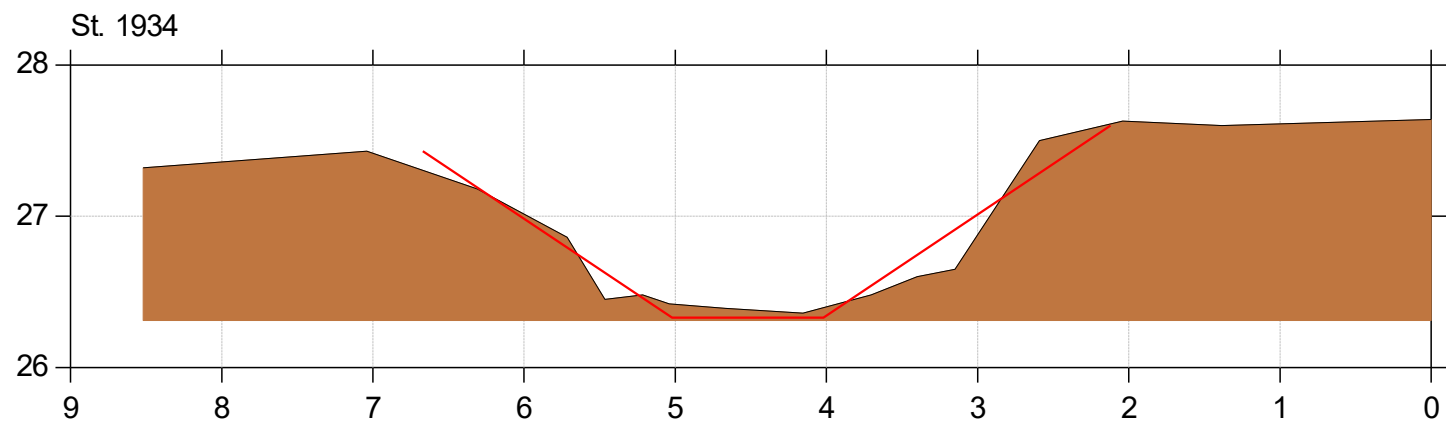
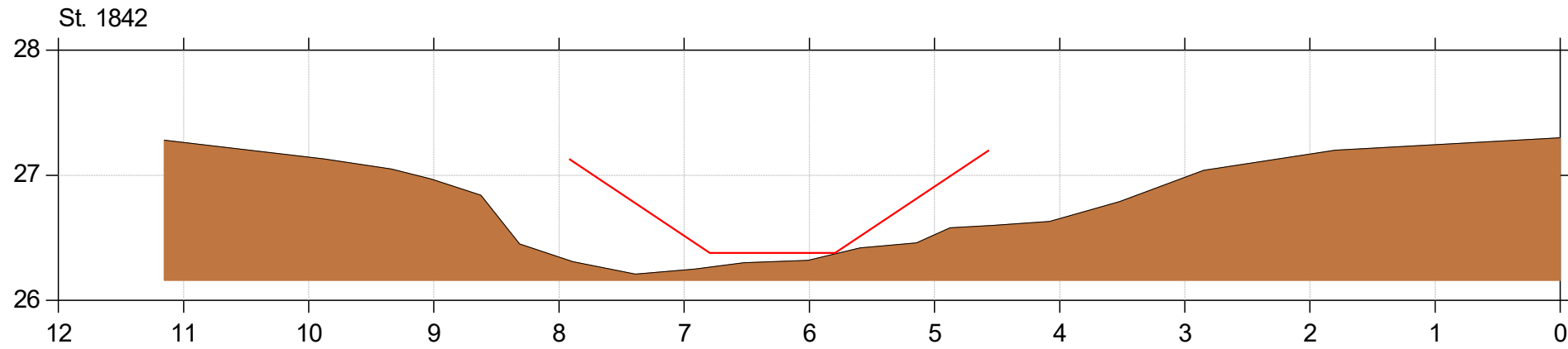

Almstrup Bæk

Regulativrevision

Lodret akse : Kote i m DVR90, skala 1:50

Vandret akse : Afstand i m, skala 1:50

- Tidligere regulativ
- Regulativ 2025
- Bund opmålt (2020/2024)

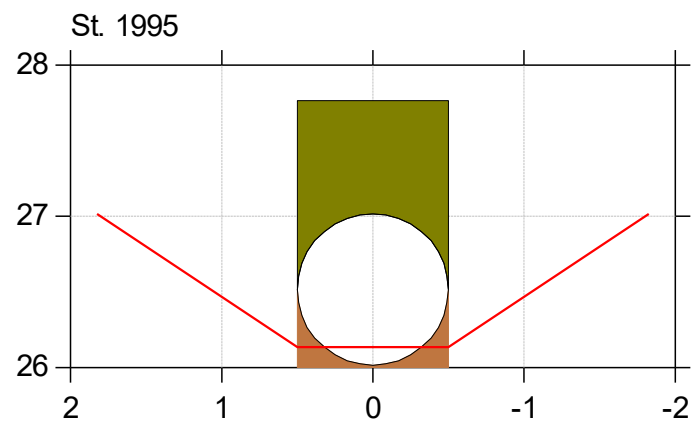
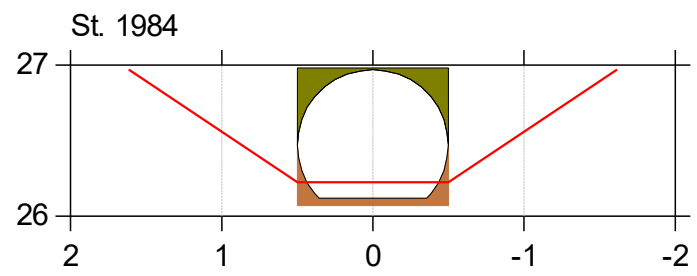
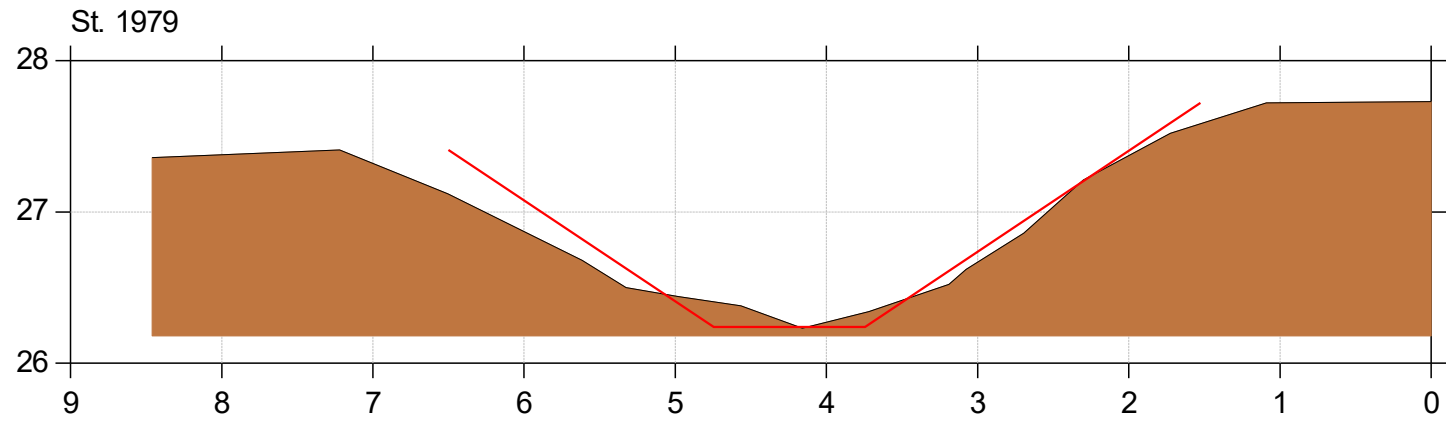

Almstrup Bæk

Regulativrevision

Lodret akse : Kote i m DVR90, skala 1:50

Vandret akse : Afstand i m, skala 1:50

- Tidligere regulativ
- Regulativ 2025
- Bund opmålt (2020/2024)

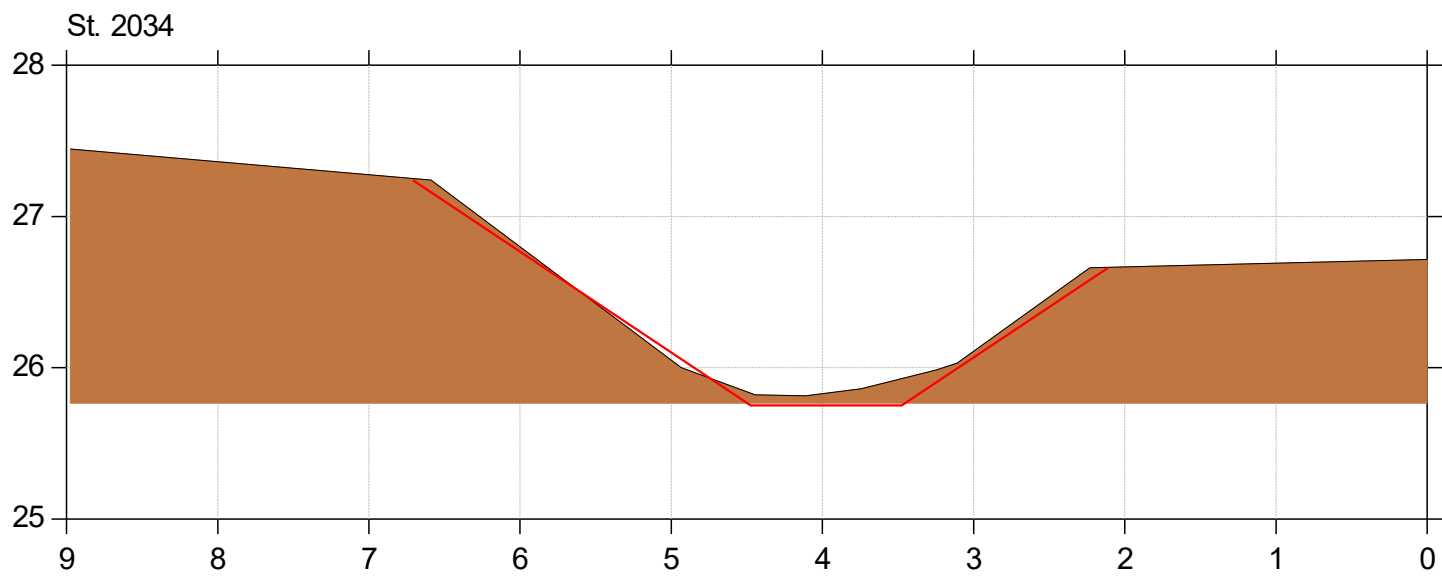
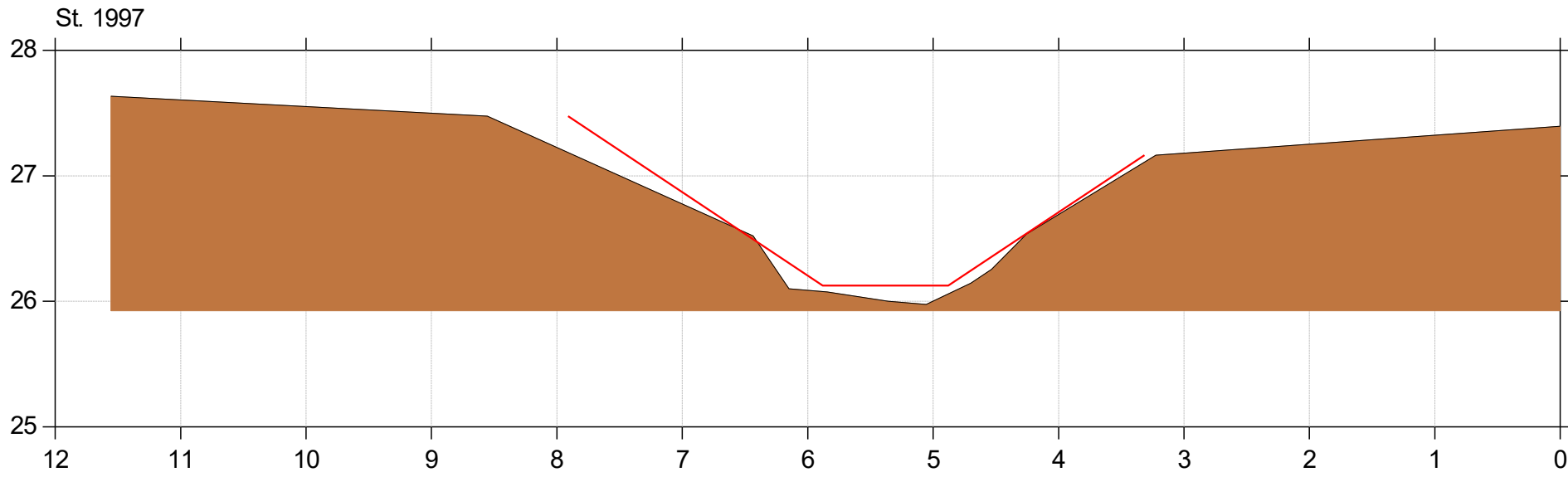

Almstrup Bæk

Regulativrevision

Lodret akse : Kote i m DVR90, skala 1:50

Vandret akse : Afstand i m, skala 1:50

- Tidligere regulativ
- Regulativ 2025
- Bund opmålt (2020/2024)

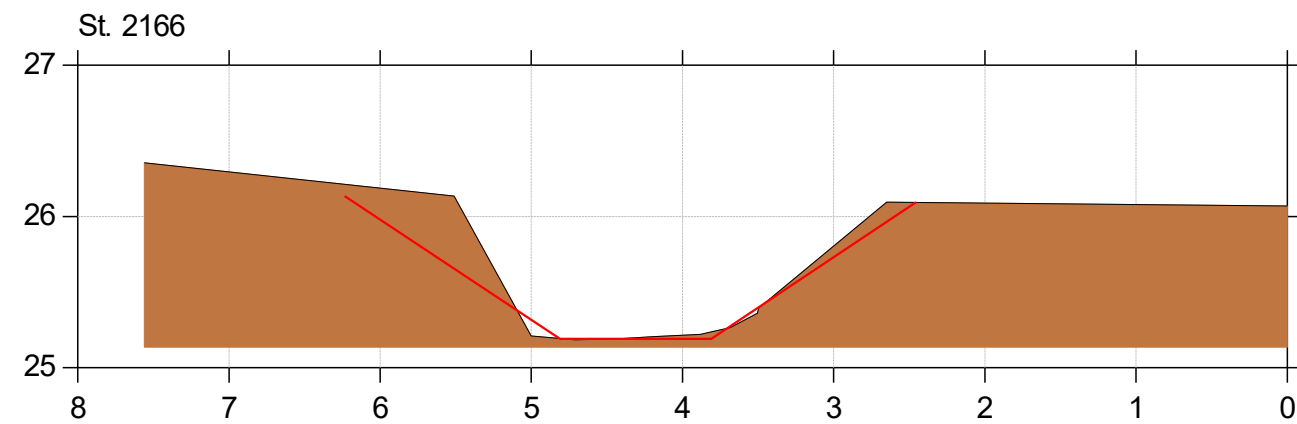
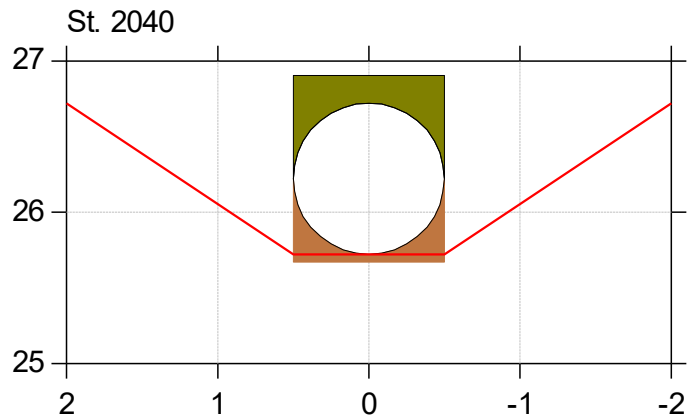
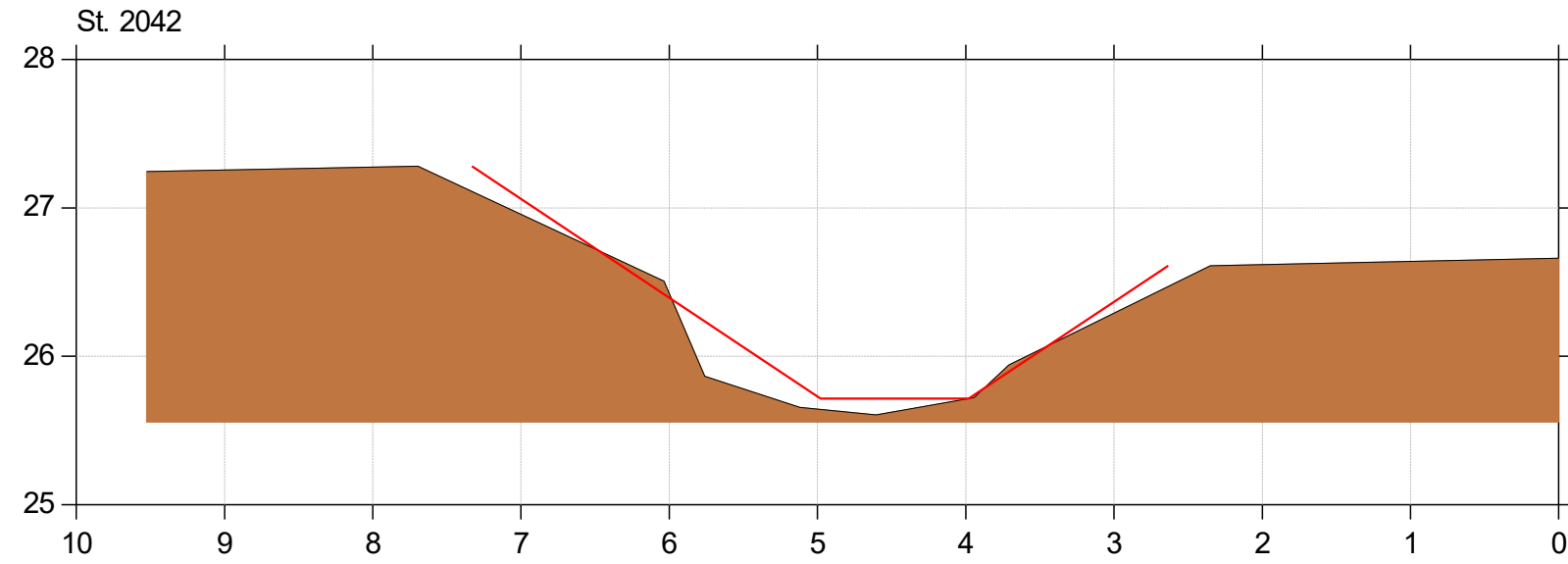
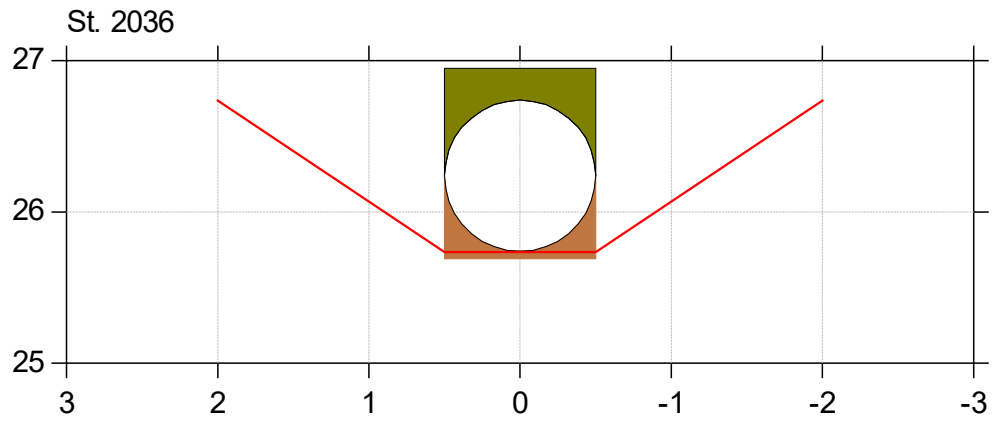

Almstrup Bæk

Regulativrevision

Lodret akse : Kote i m DVR90, skala 1:50

Vandret akse : Afstand i m, skala 1:50

- Tidligere regulativ
- Regulativ 2025
- Bund opmålt (2020/2024)

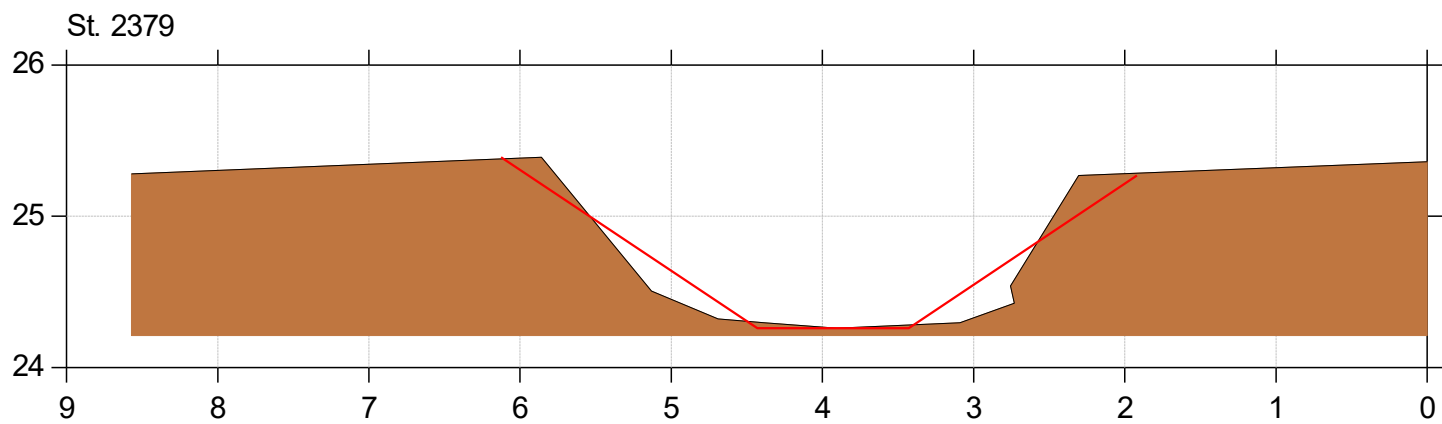
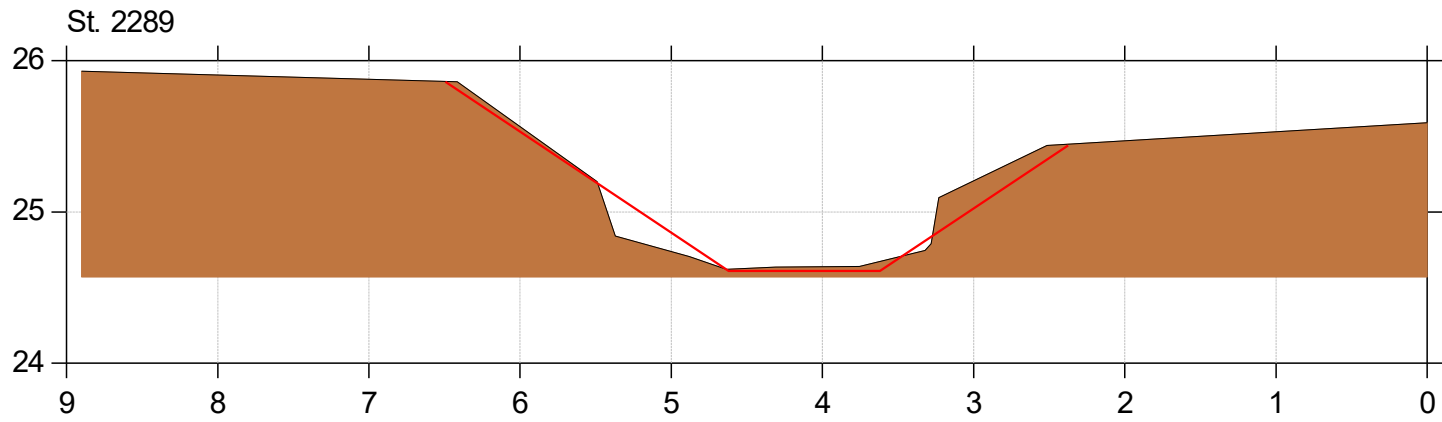

Almstrup Bæk

Regulativrevision

Lodret akse : Kote i m DVR90, skala 1:50

Vandret akse : Afstand i m, skala 1:50

- Tidligere regulativ
- Regulativ 2025
- Bund opmålt (2020/2024)

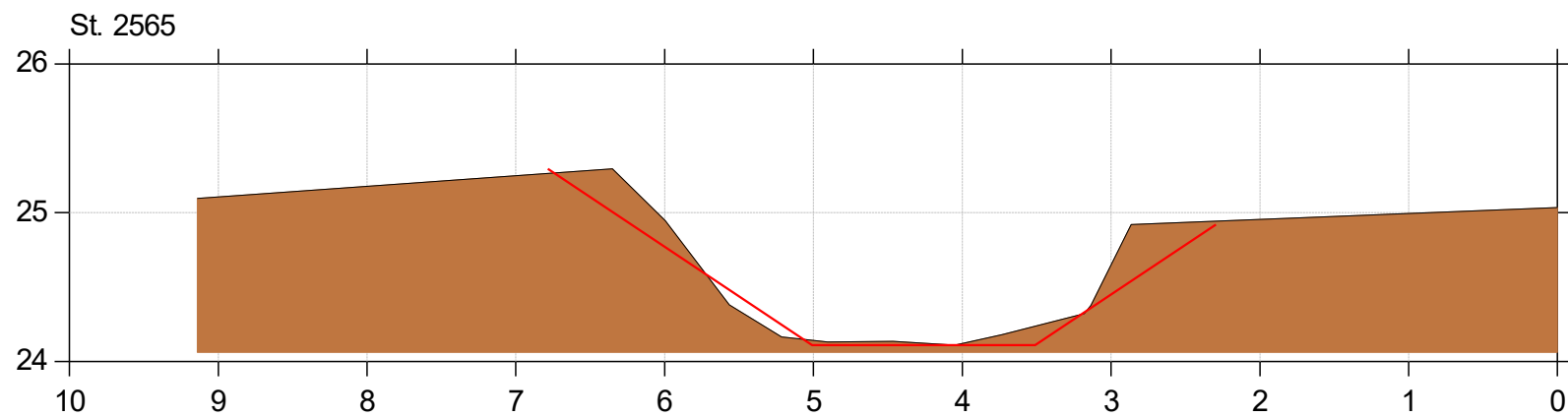
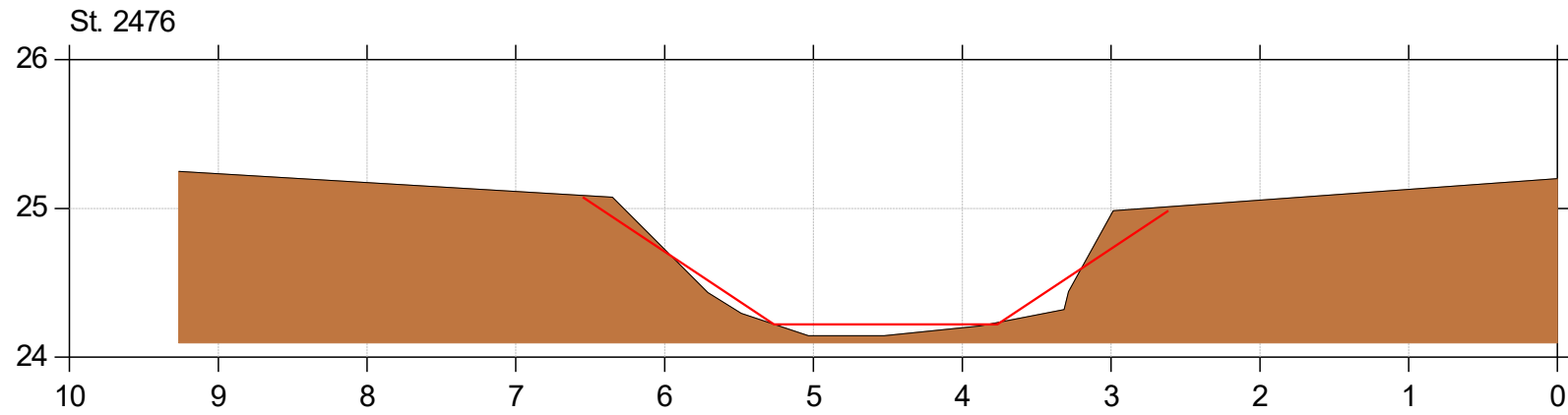

Almstrup Bæk

Regulativrevision

Lodret akse : Kote i m DVR90, skala 1:50

Vandret akse : Afstand i m, skala 1:50

- Tidligere regulativ
- Regulativ 2025
- Bund opmålt (2020/2024)

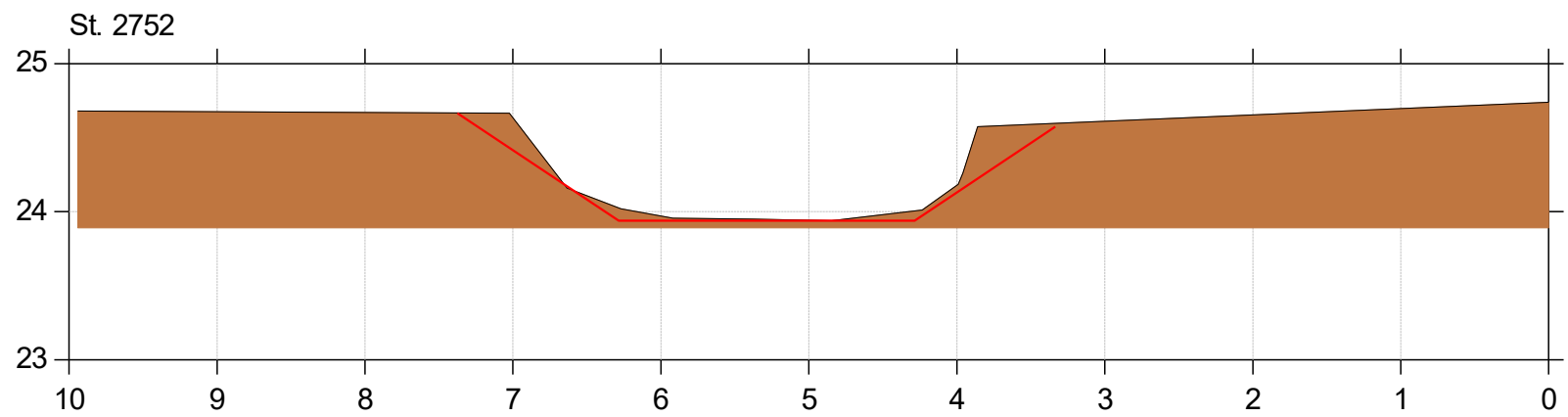
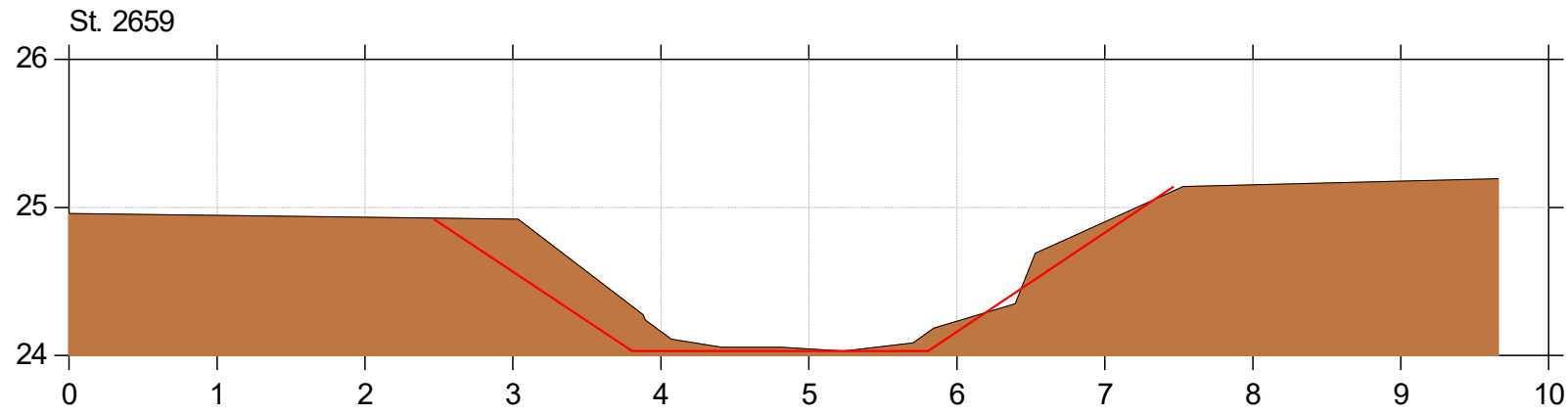

Almstrup Bæk

Regulativrevision

Lodret akse : Kote i m DVR90, skala 1:50

Vandret akse : Afstand i m, skala 1:50

- Tidligere regulativ
- Regulativ 2025
- Bund opmålt (2020/2024)

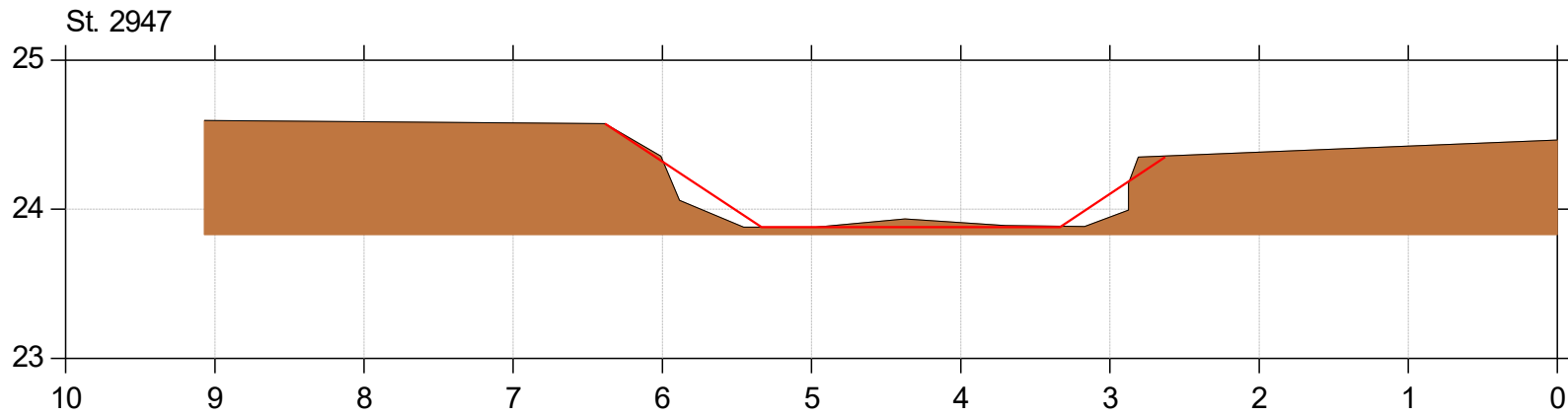
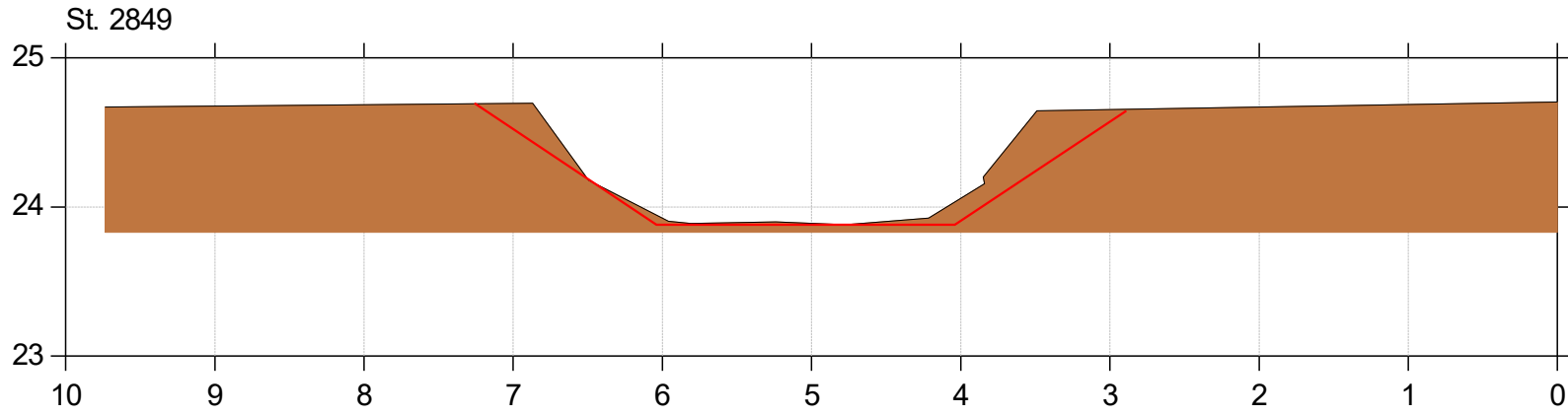

Almstrup Bæk

Regulativrevision

Lodret akse : Kote i m DVR90, skala 1:50

Vandret akse : Afstand i m, skala 1:50

- Tidligere regulativ
- Regulativ 2025
- Bund opmålt (2020/2024)

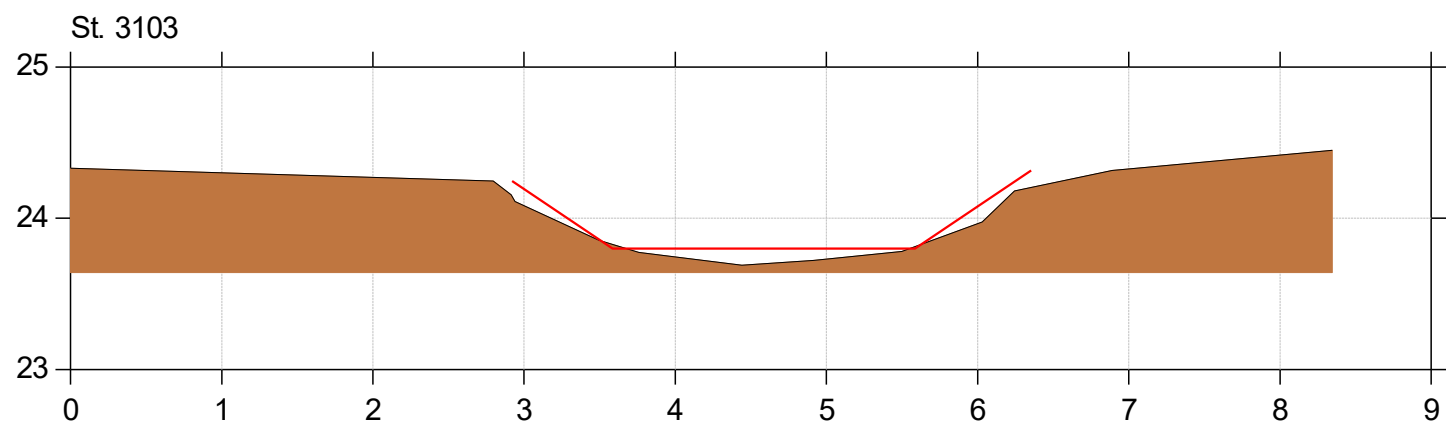
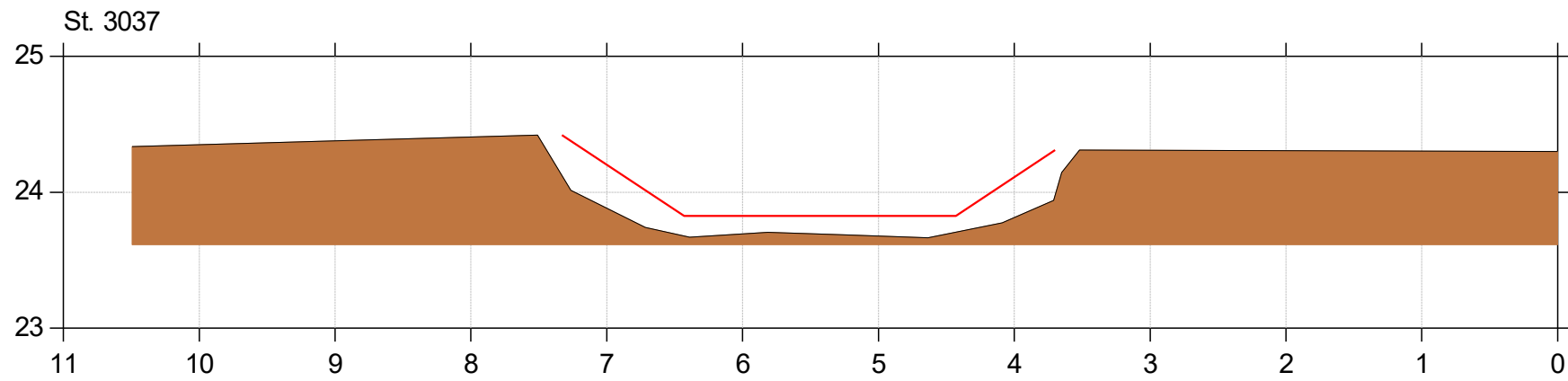

Almstrup Bæk

Regulativrevision

Lodret akse : Kote i m DVR90, skala 1:50

Vandret akse : Afstand i m, skala 1:50

- Tidligere regulativ
- Regulativ 2025
- Bund opmålt (2020/2024)

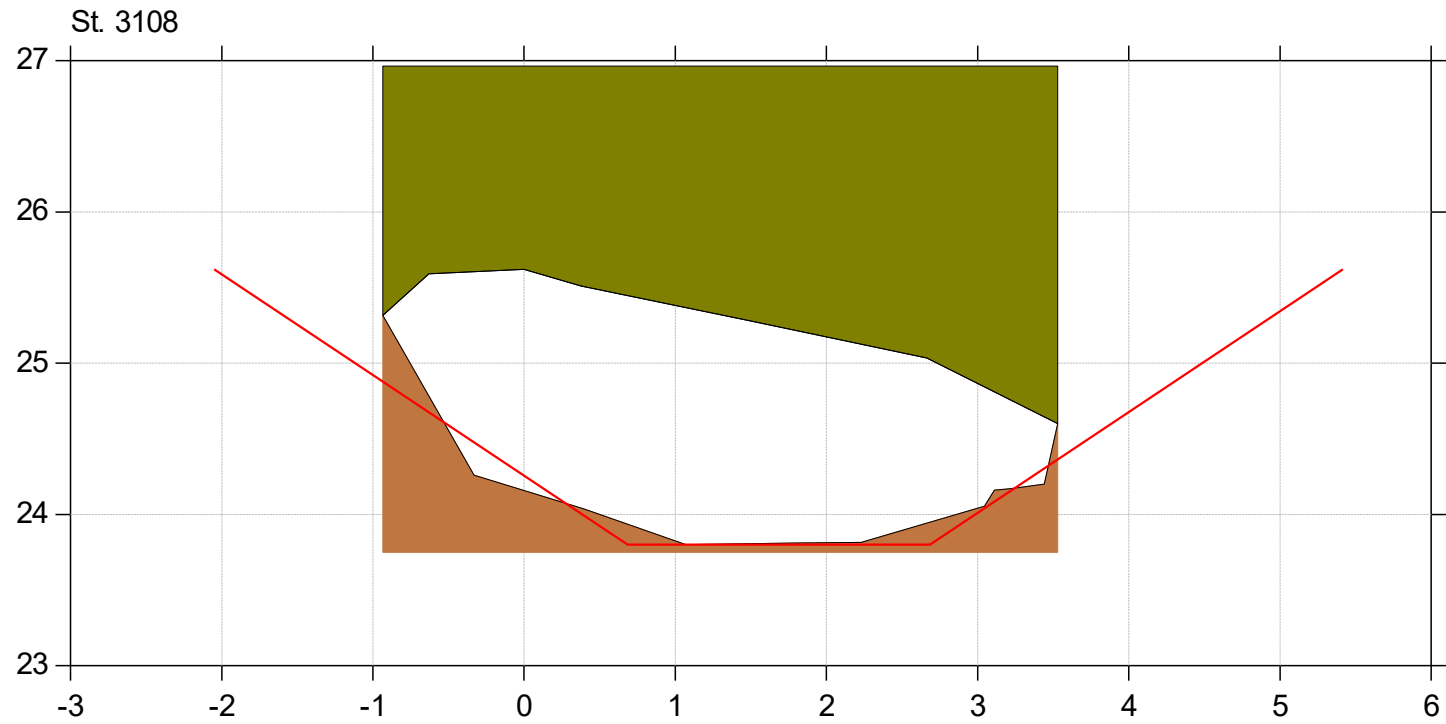

Almstrup Bæk

Regulativrevision

Lodret akse : Kote i m DVR90, skala 1:50

Vandret akse : Afstand i m, skala 1:50

- Tidligere regulativ
- Regulativ 2025
- Bund opmålt (2020/2024)

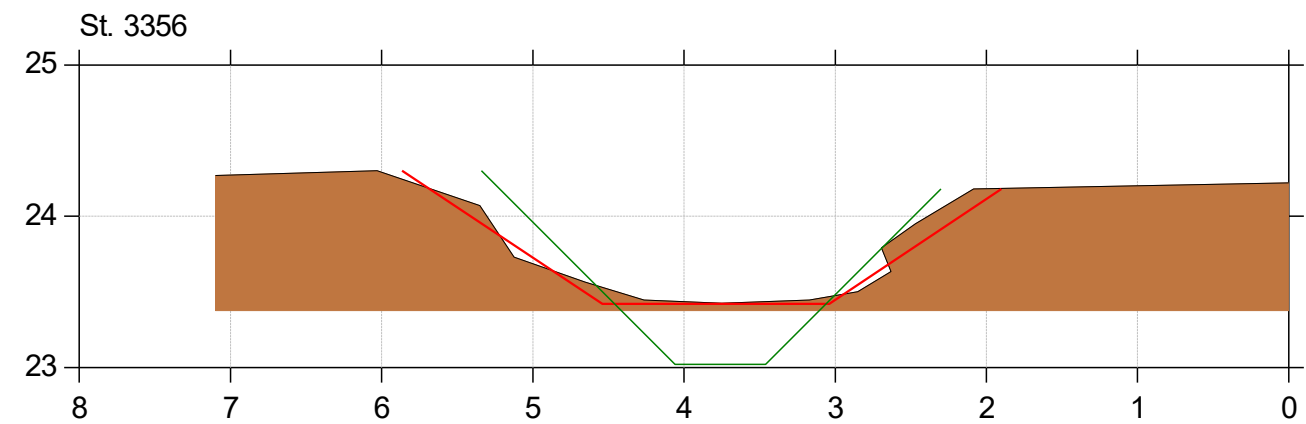
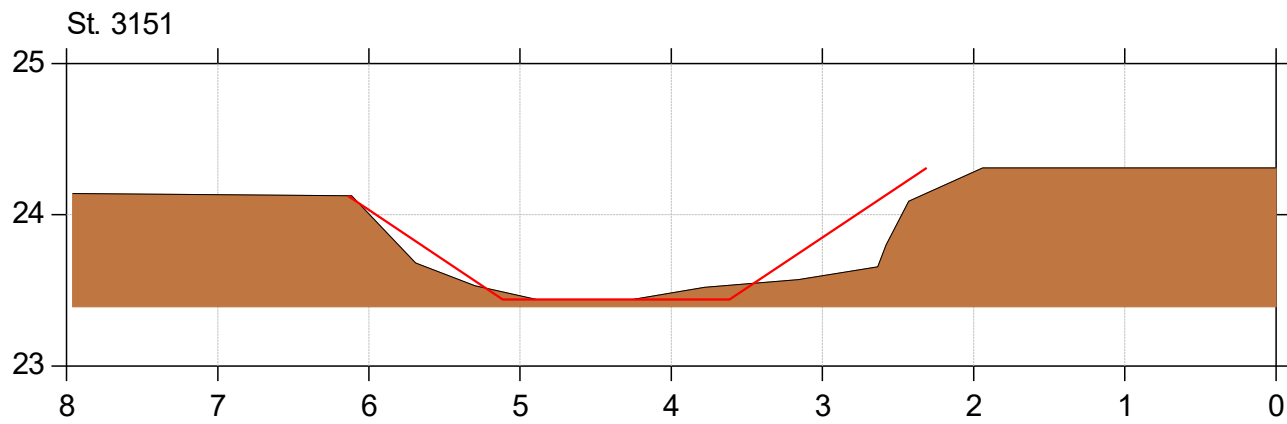
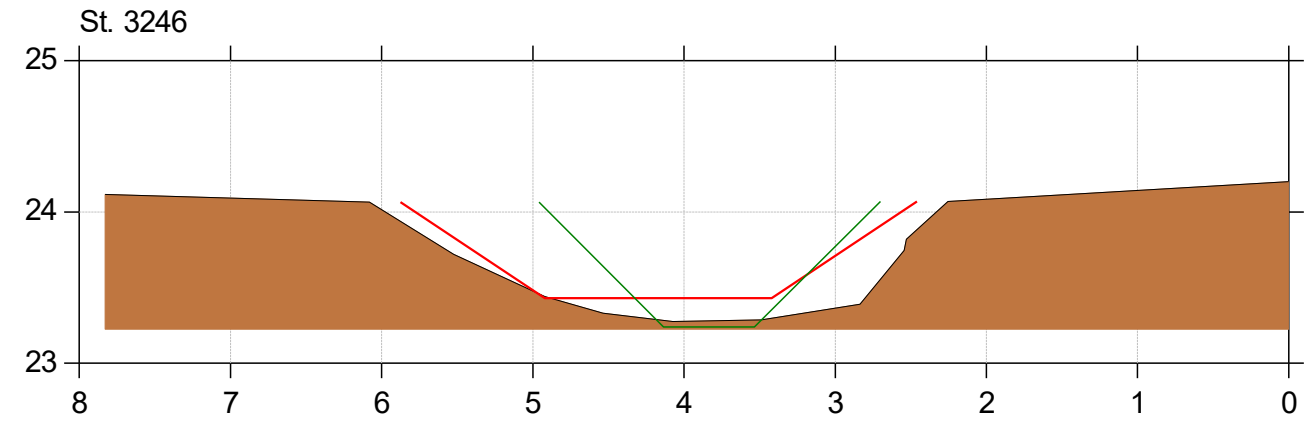
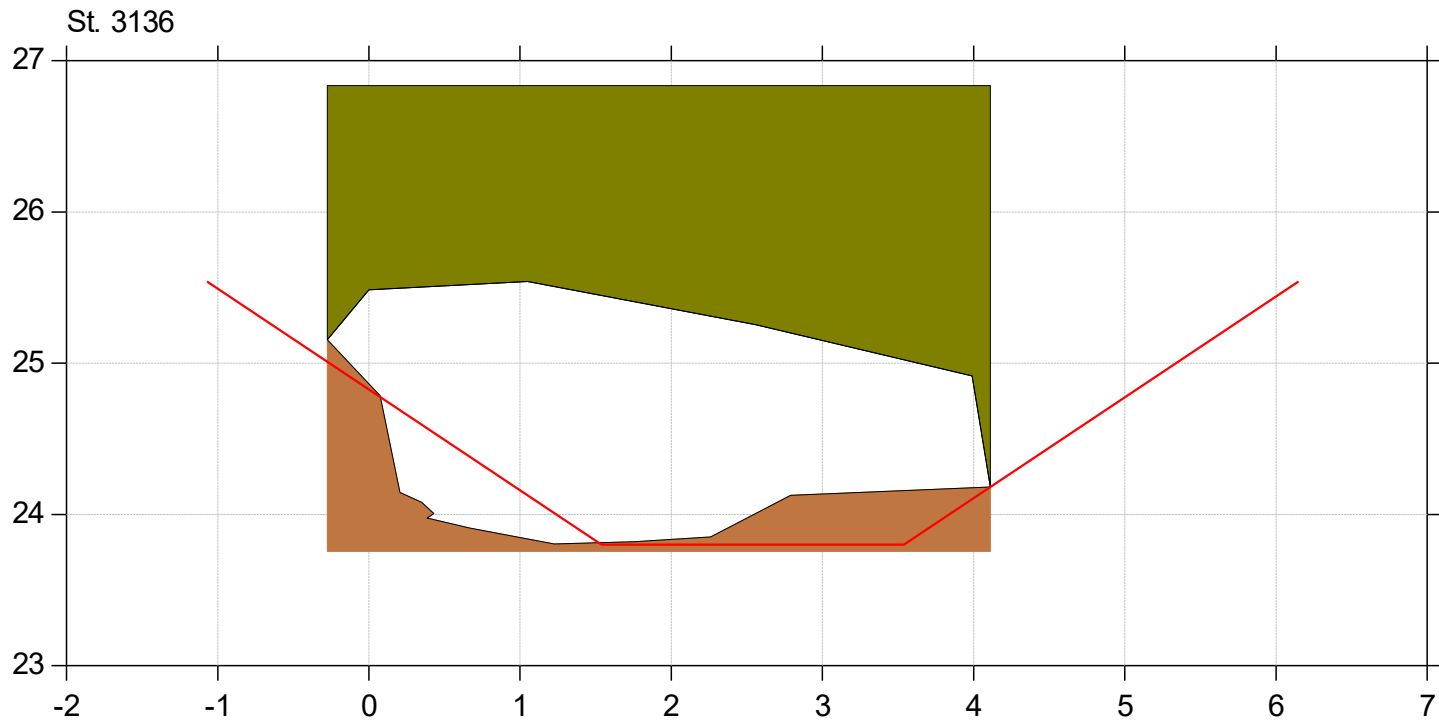

Almstrup Bæk

Regulativrevision

Lodret akse : Kote i m DVR90, skala 1:50

Vandret akse : Afstand i m, skala 1:50

- Tidligere regulativ
- Regulativ 2025
- Bund opmålt (2020/2024)

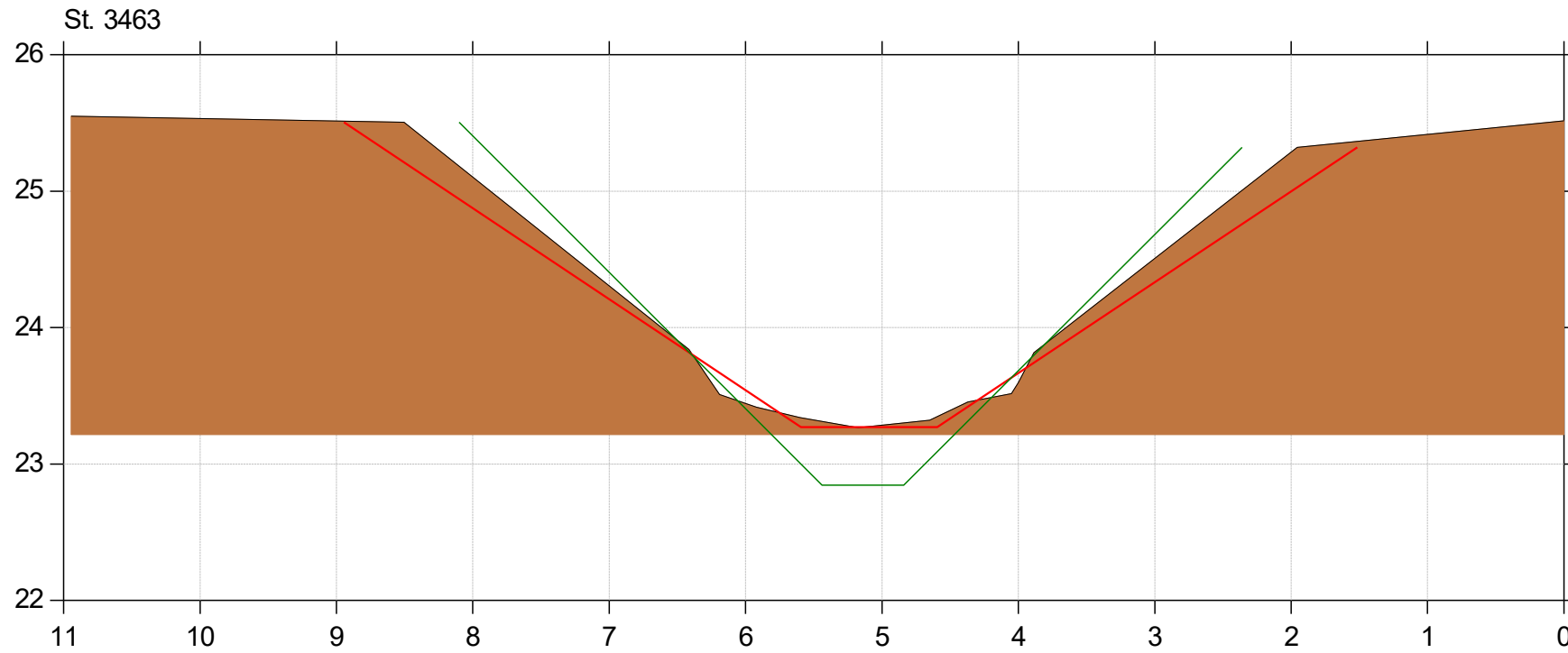

Almstrup Bæk

Regulativrevision

Lodret akse : Kote i m DVR90, skala 1:50

Vandret akse : Afstand i m, skala 1:50

- Tidligere regulativ
- Regulativ 2025
- Bund opmålt (2020/2024)

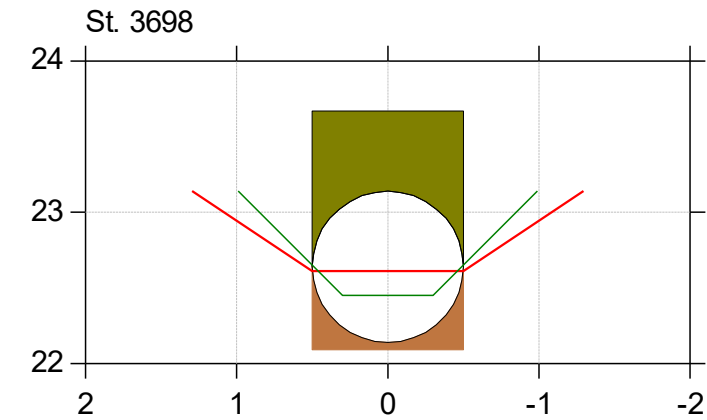
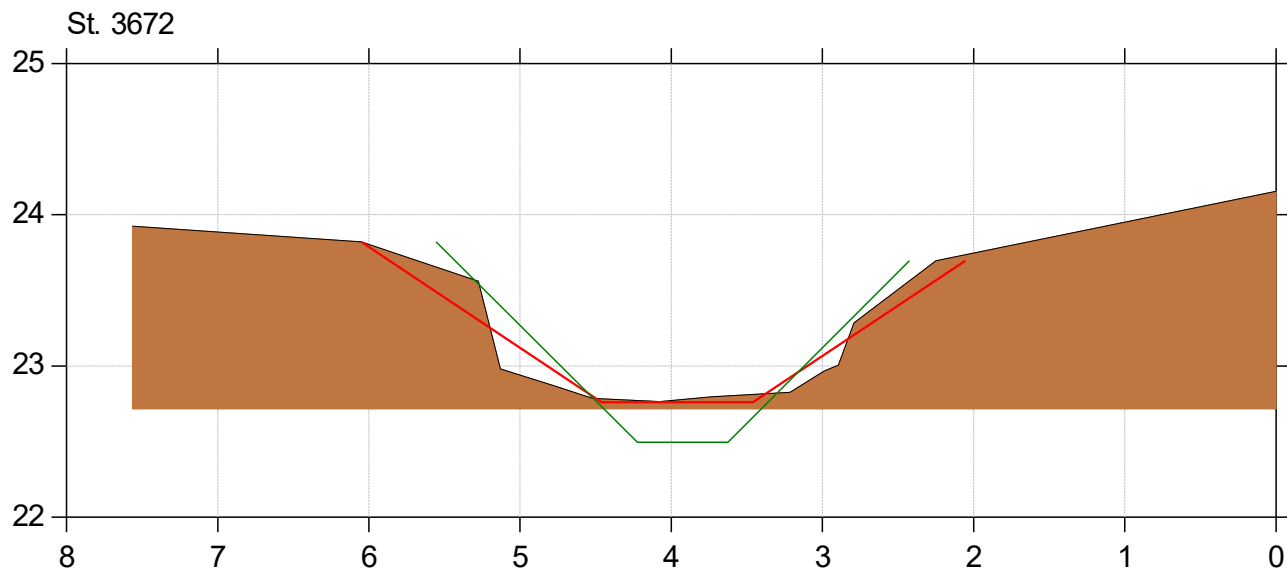
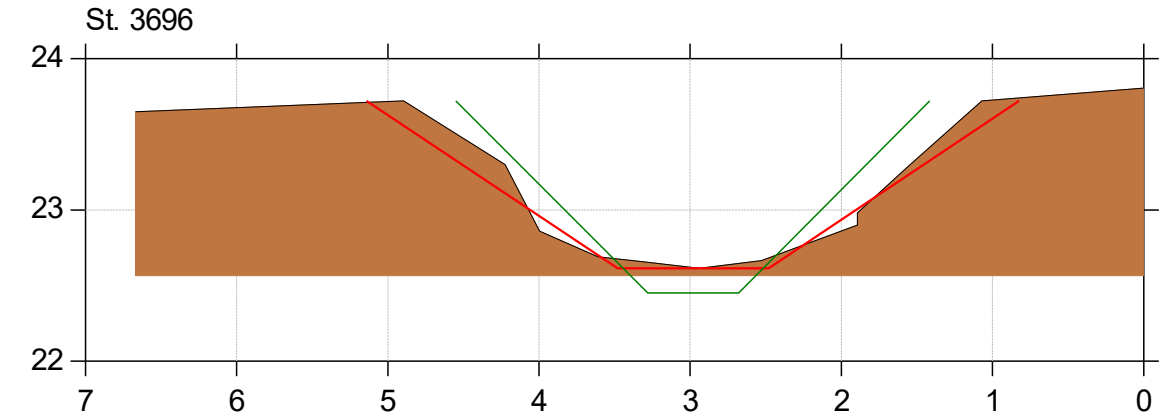
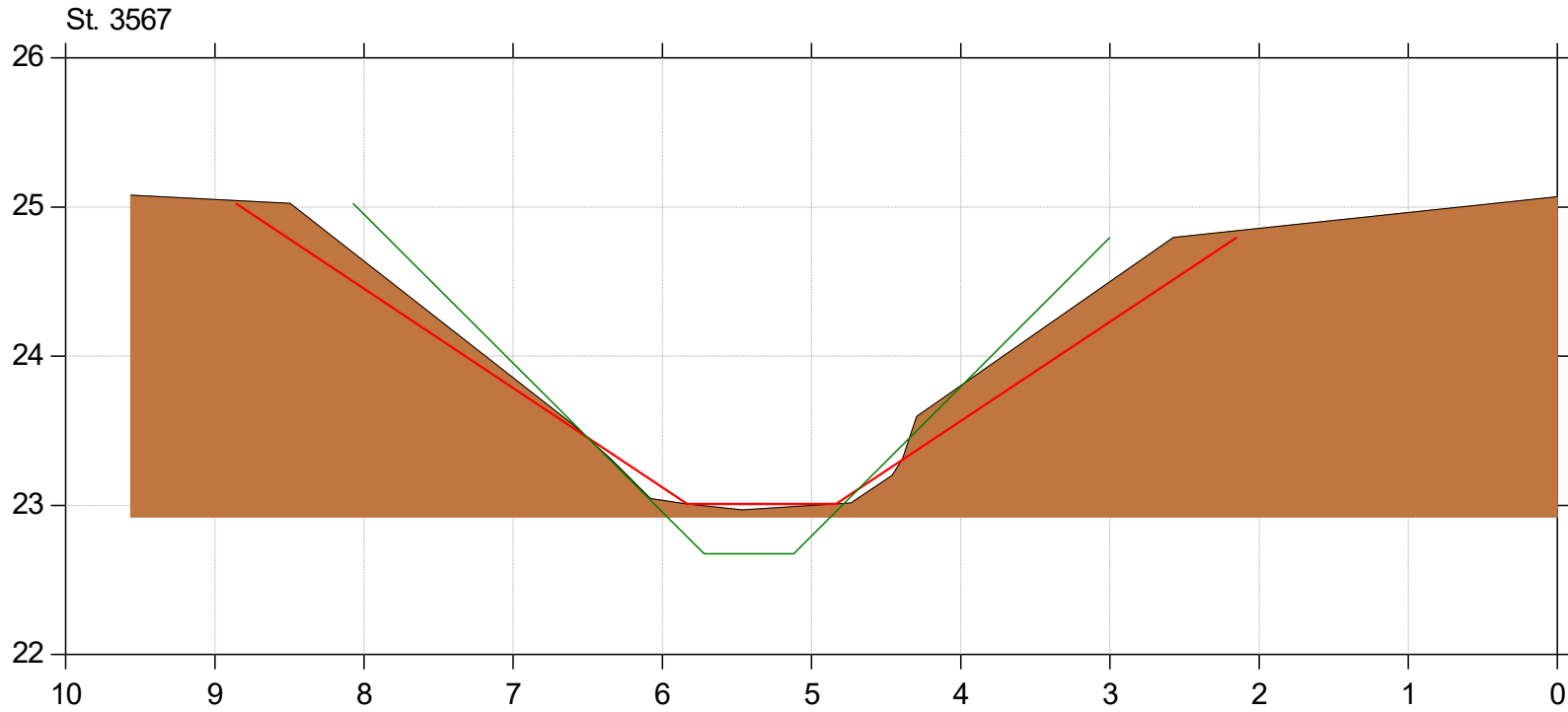

Almstrup Bæk

Regulativrevision

Lodret akse : Kote i m DVR90, skala 1:50

Vandret akse : Afstand i m, skala 1:50

- Tidligere regulativ
- Regulativ 2025
- Bund opmålt (2020/2024)

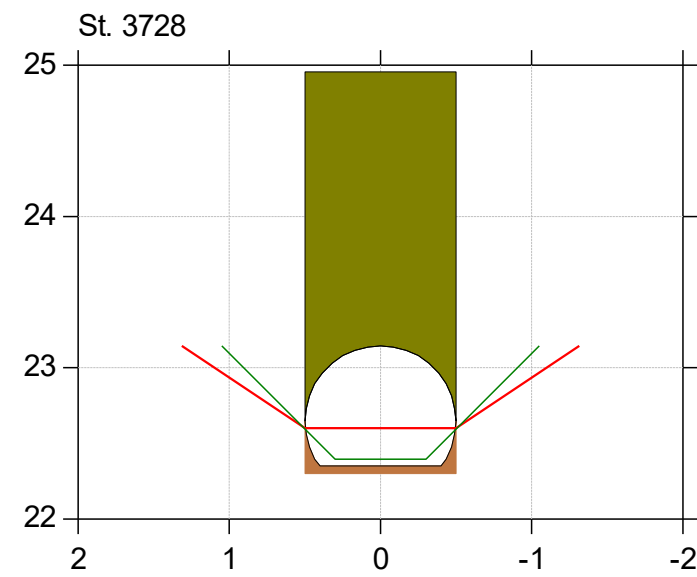
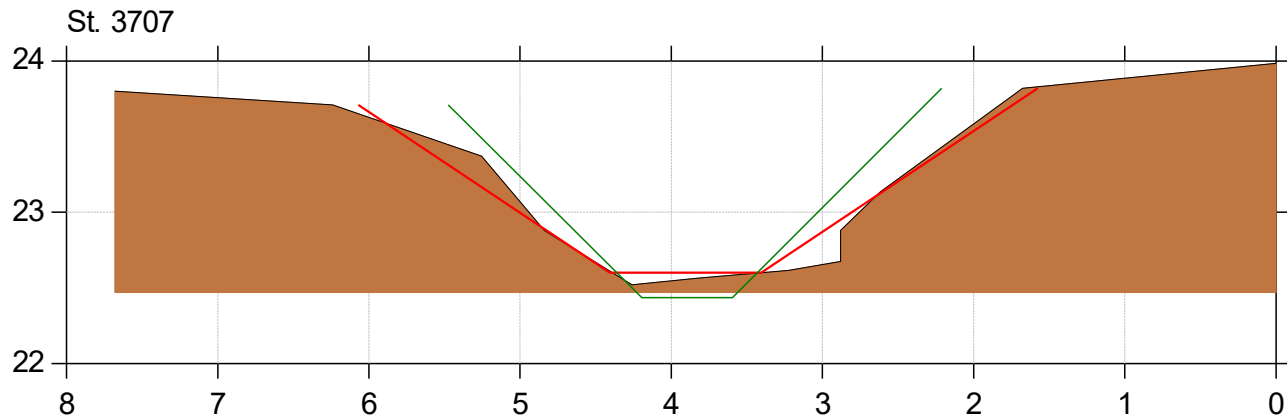
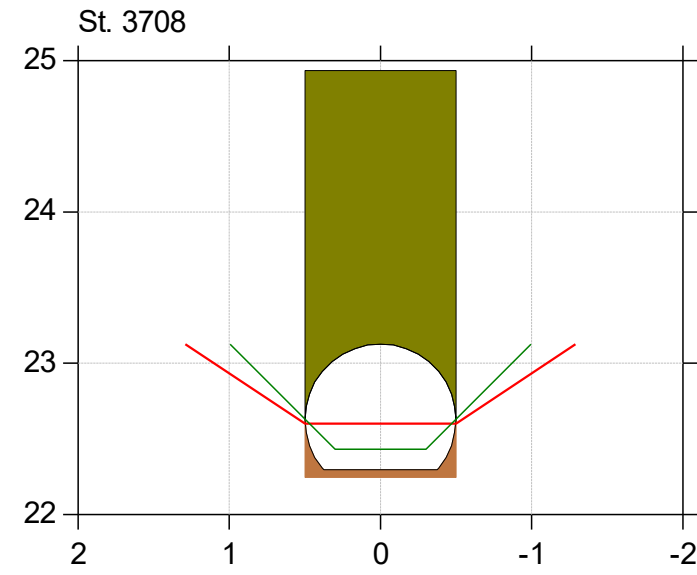
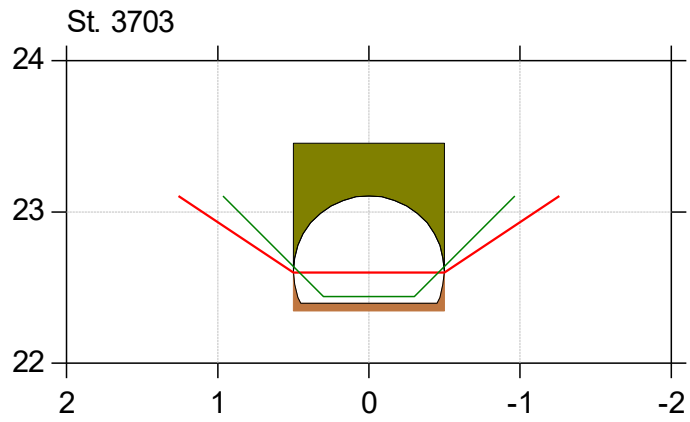

Almstrup Bæk

Regulativrevision

Lodret akse : Kote i m DVR90, skala 1:50

Vandret akse : Afstand i m, skala 1:50

- Tidligere regulativ
- Regulativ 2025
- Bund opmålt (2020/2024)

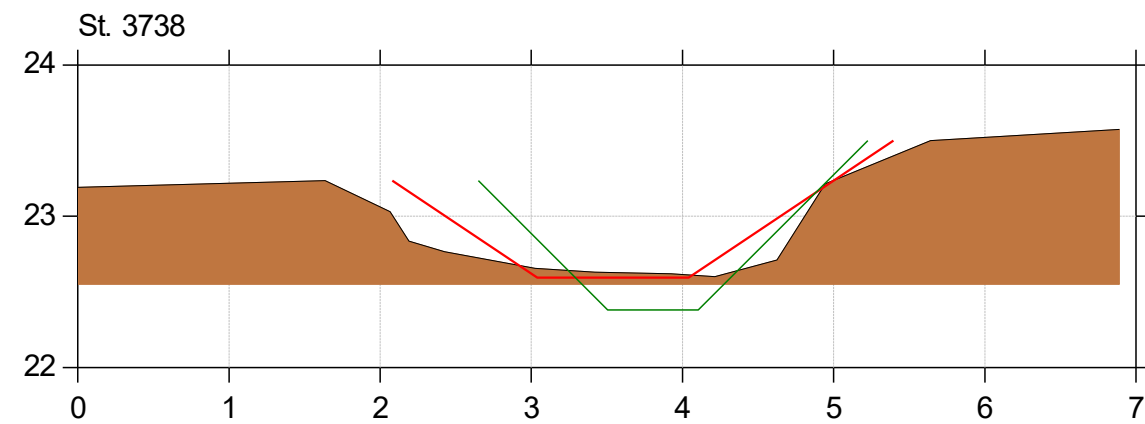
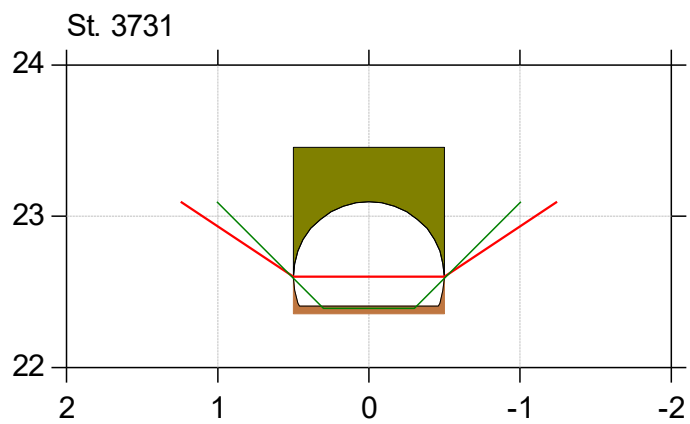
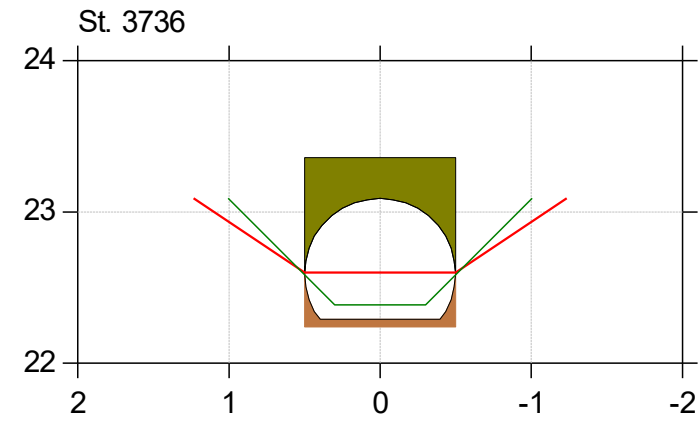
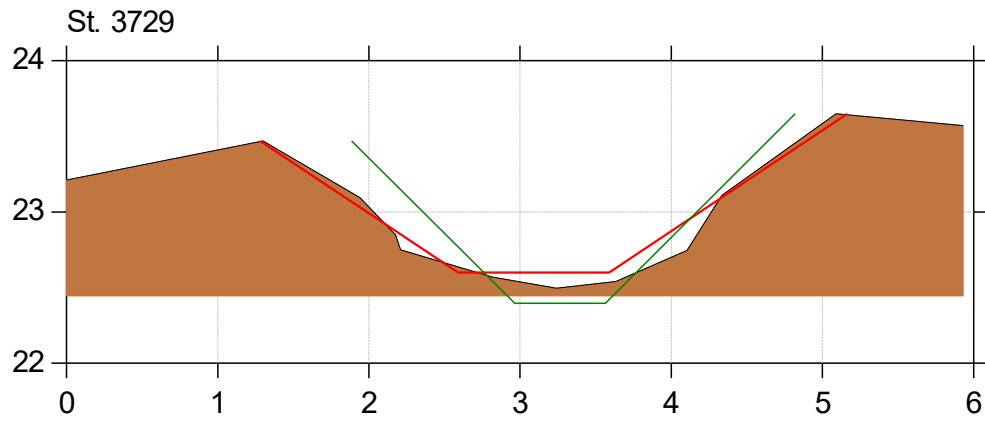

Almstrup Bæk

Regulativrevision

Lodret akse : Kote i m DVR90, skala 1:50

Vandret akse : Afstand i m, skala 1:50

- Tidligere regulativ
- Regulativ 2025
- Bund opmålt (2020/2024)

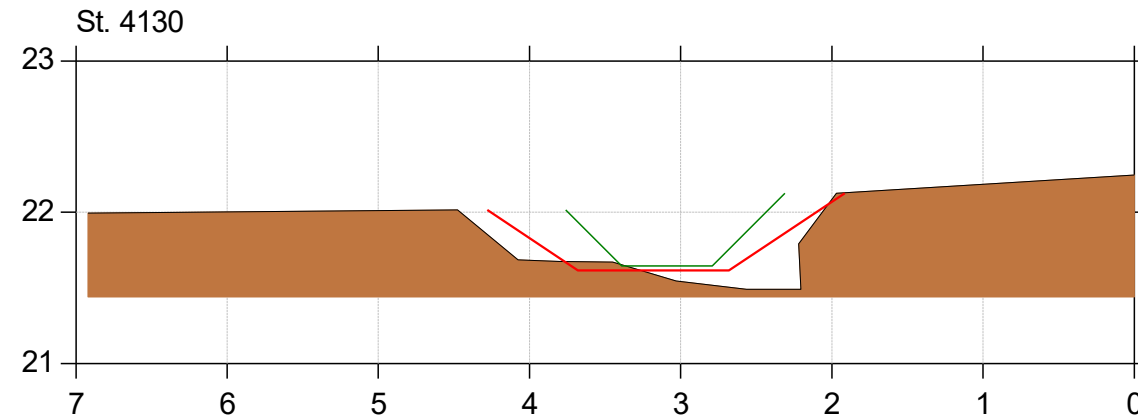
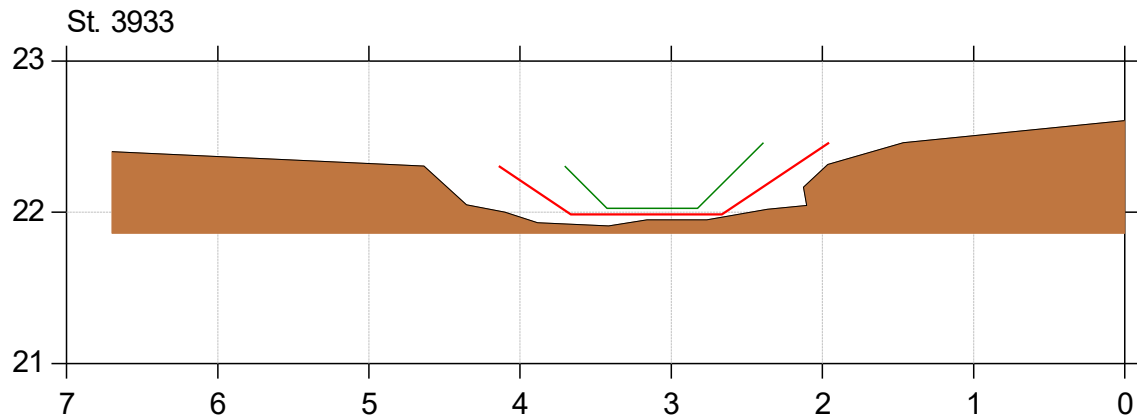
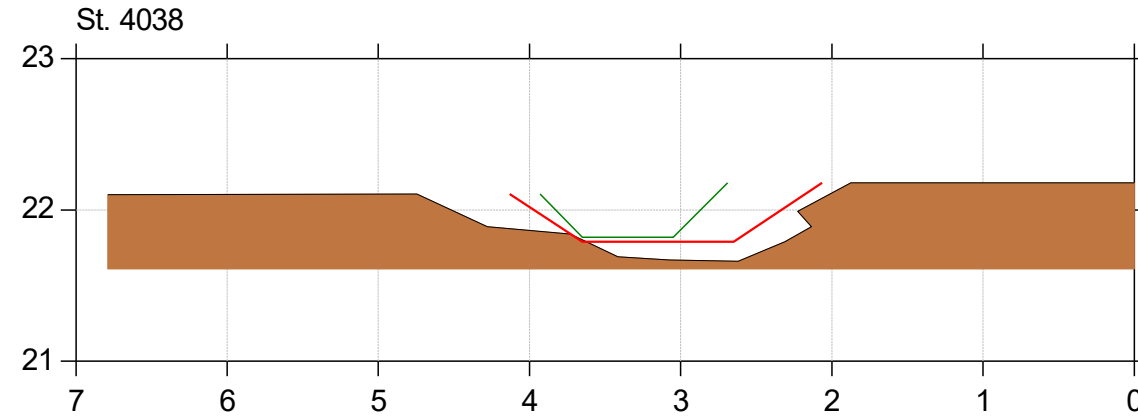
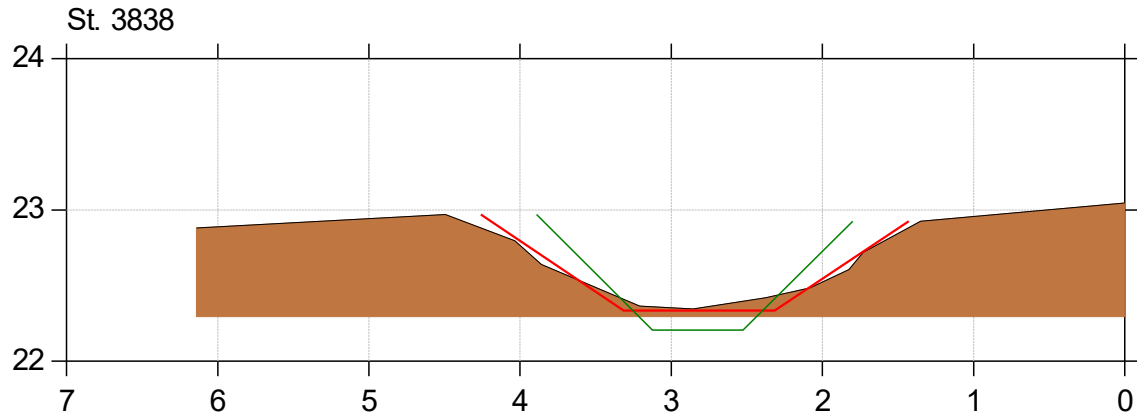

Almstrup Bæk

Regulativrevision

Lodret akse : Kote i m DVR90, skala 1:50

Vandret akse : Afstand i m, skala 1:50

- Tidligere regulativ
- Regulativ 2025
- Bund opmålt (2020/2024)

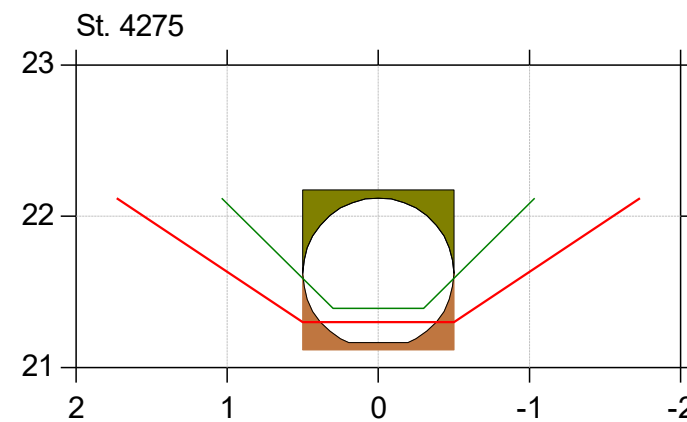
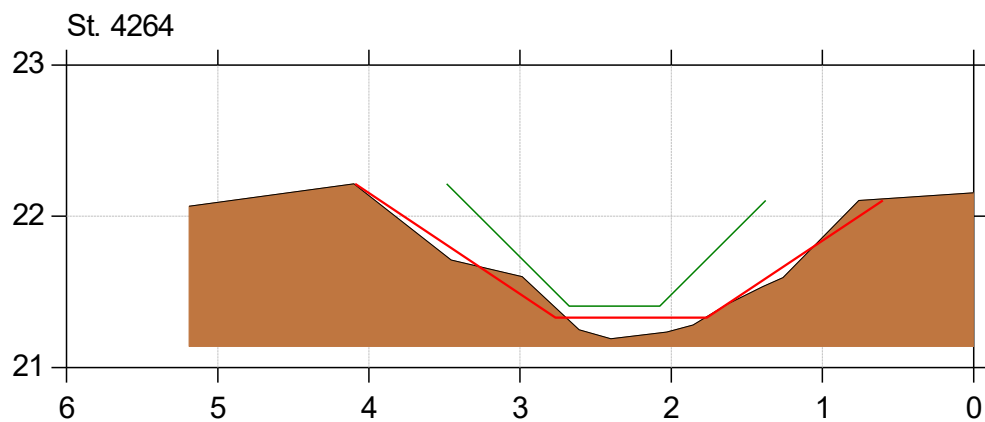
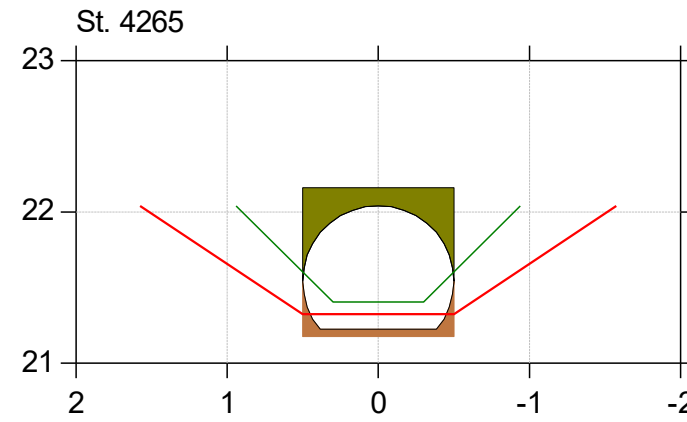
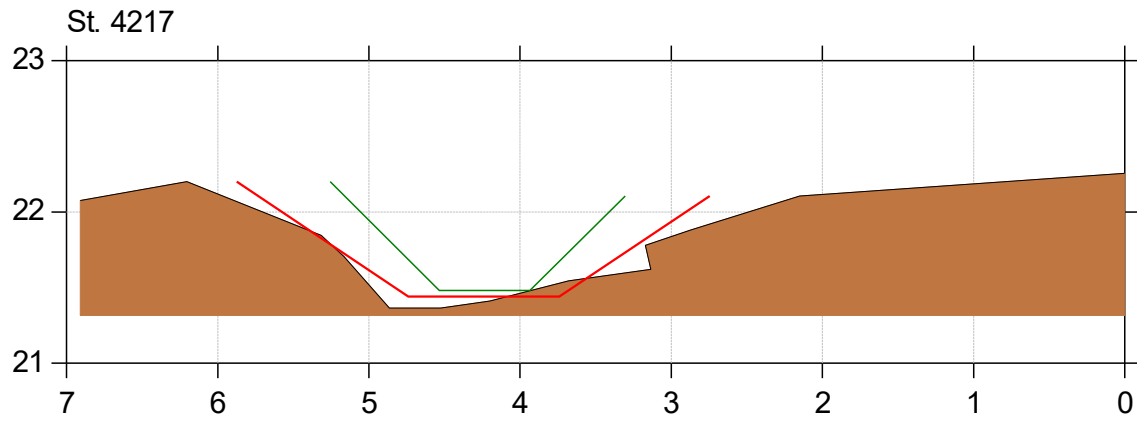

Almstrup Bæk

Regulativrevision

Lodret akse : Kote i m DVR90, skala 1:50

Vandret akse : Afstand i m, skala 1:50

- Tidligere regulativ
- Regulativ 2025
- Bund opmålt (2020/2024)

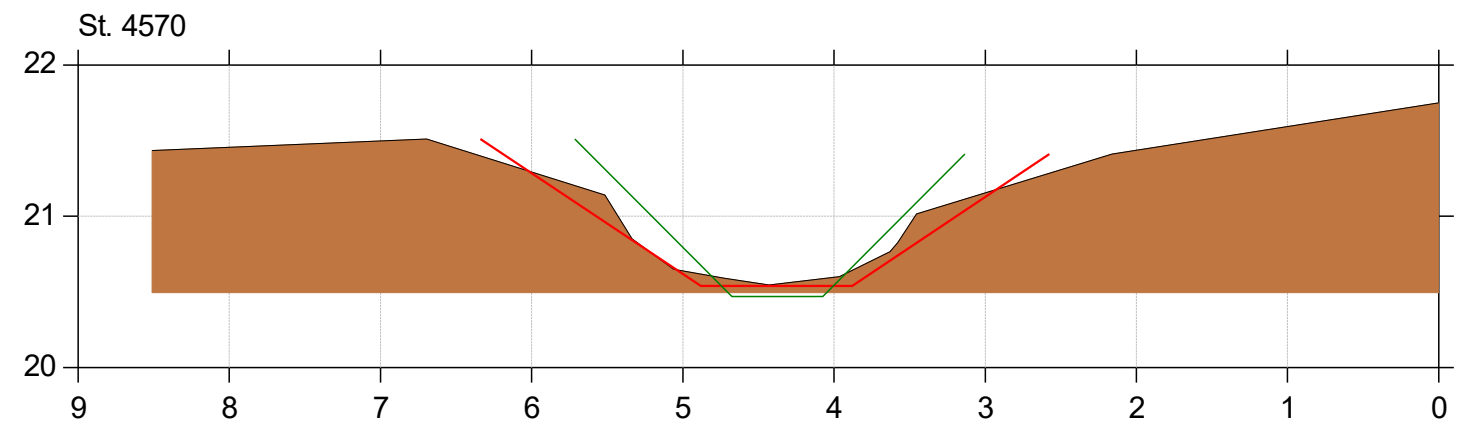
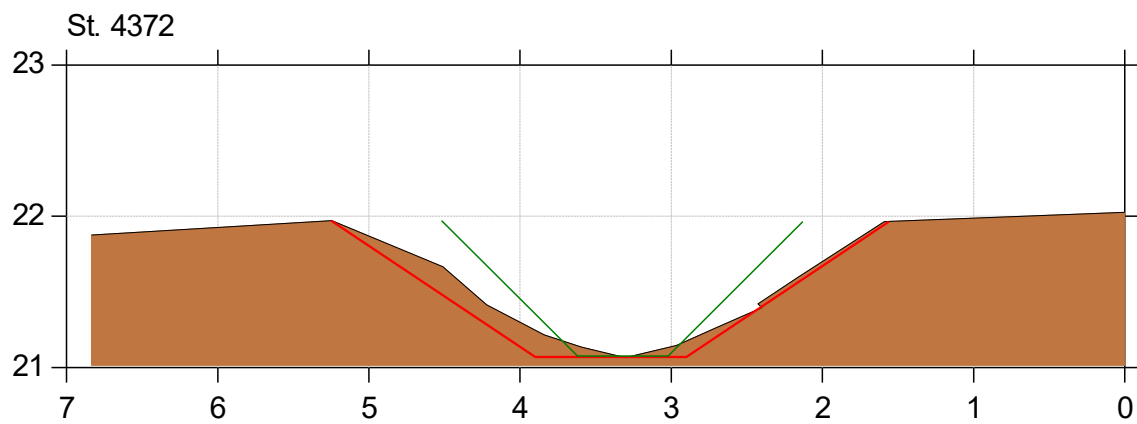
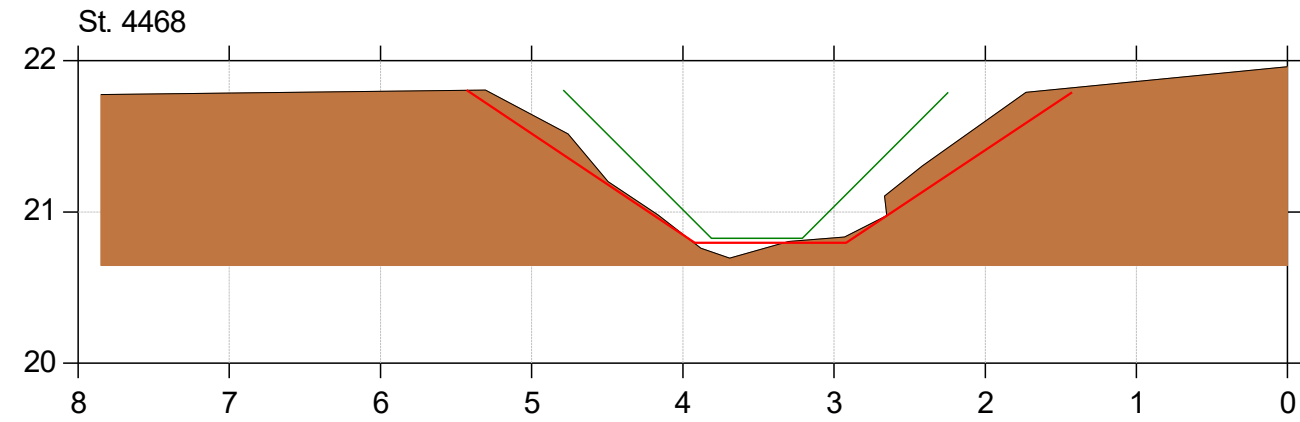
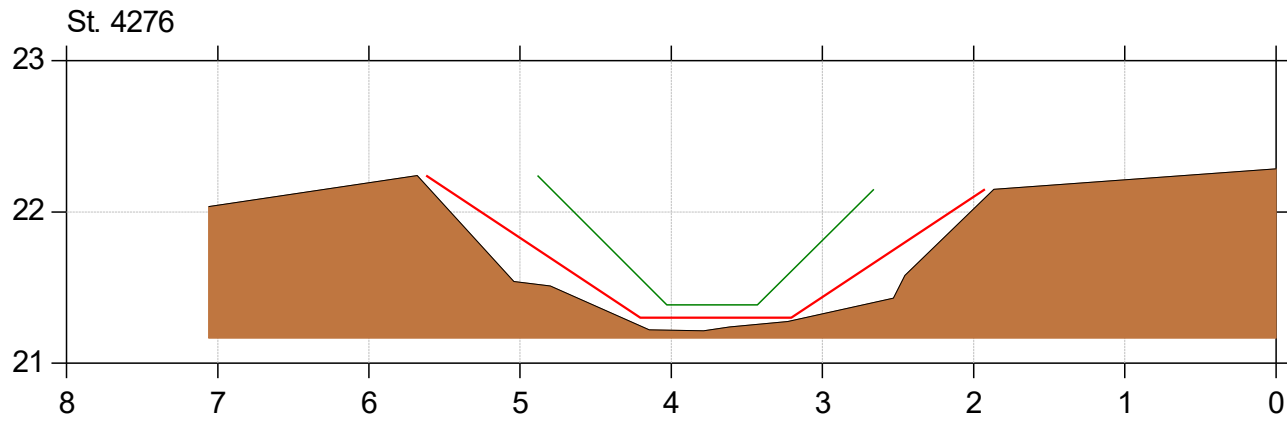

Almstrup Bæk

Regulativrevision

Lodret akse : Kote i m DVR90, skala 1:50

Vandret akse : Afstand i m, skala 1:50

- Tidligere regulativ
- Regulativ 2025
- Bund opmålt (2020/2024)

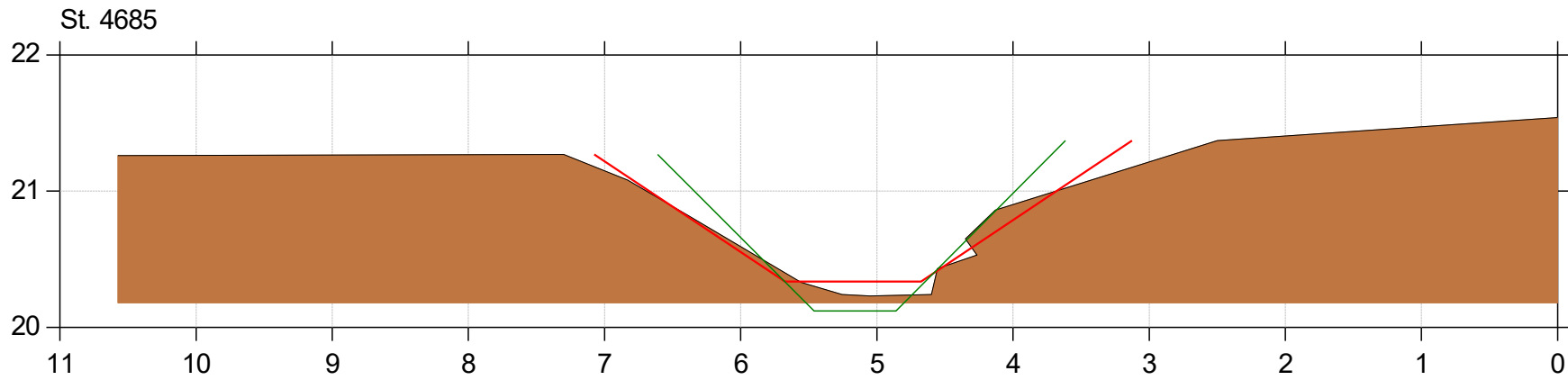
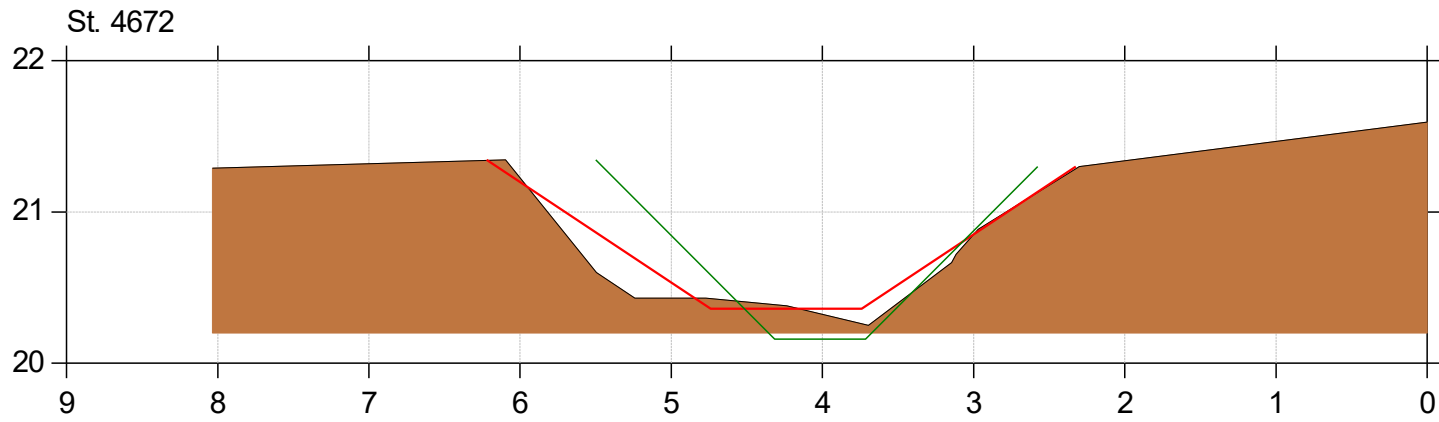

Almstrup Bæk

Regulativrevision

Lodret akse : Kote i m DVR90, skala 1:50

Vandret akse : Afstand i m, skala 1:50

- Tidligere regulativ
- Regulativ 2025
- Bund opmålt (2020/2024)

St. 4723

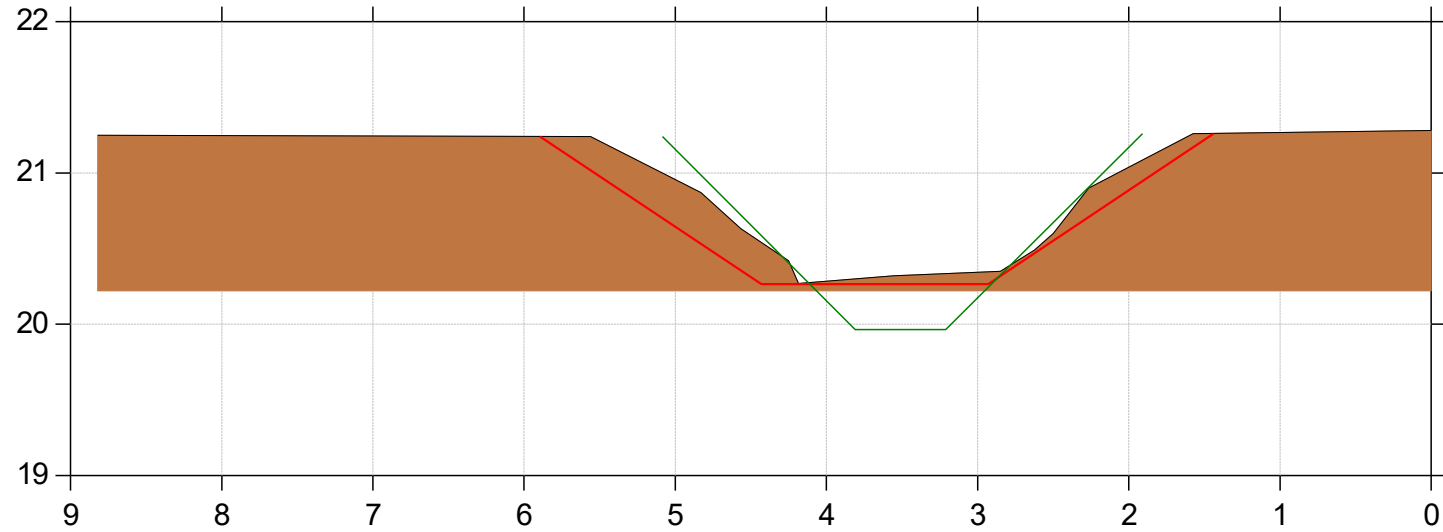

St. 4754

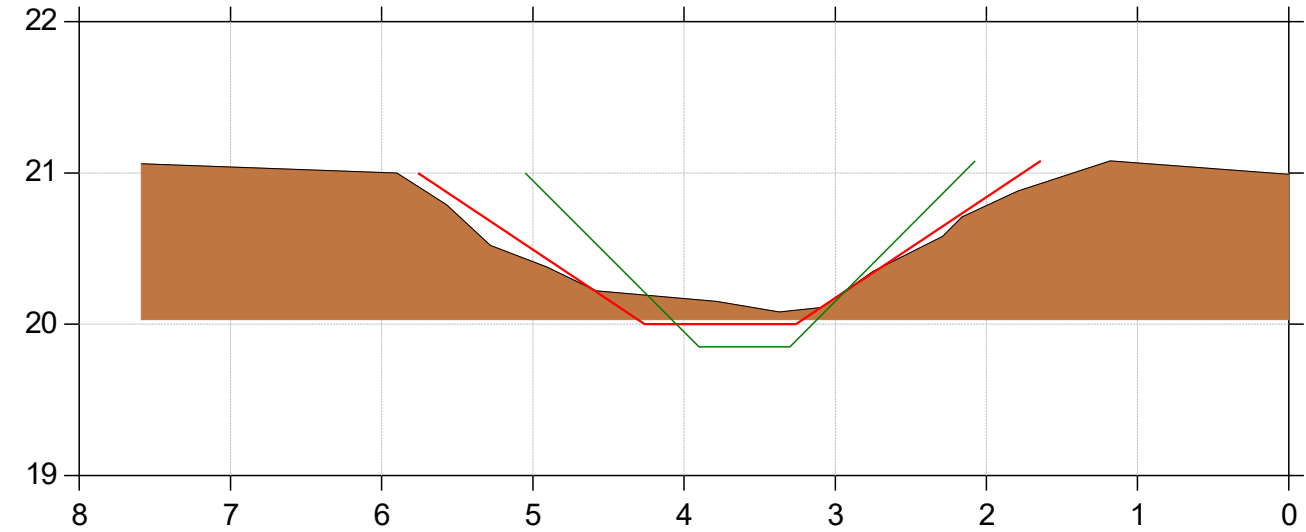

St. 4737

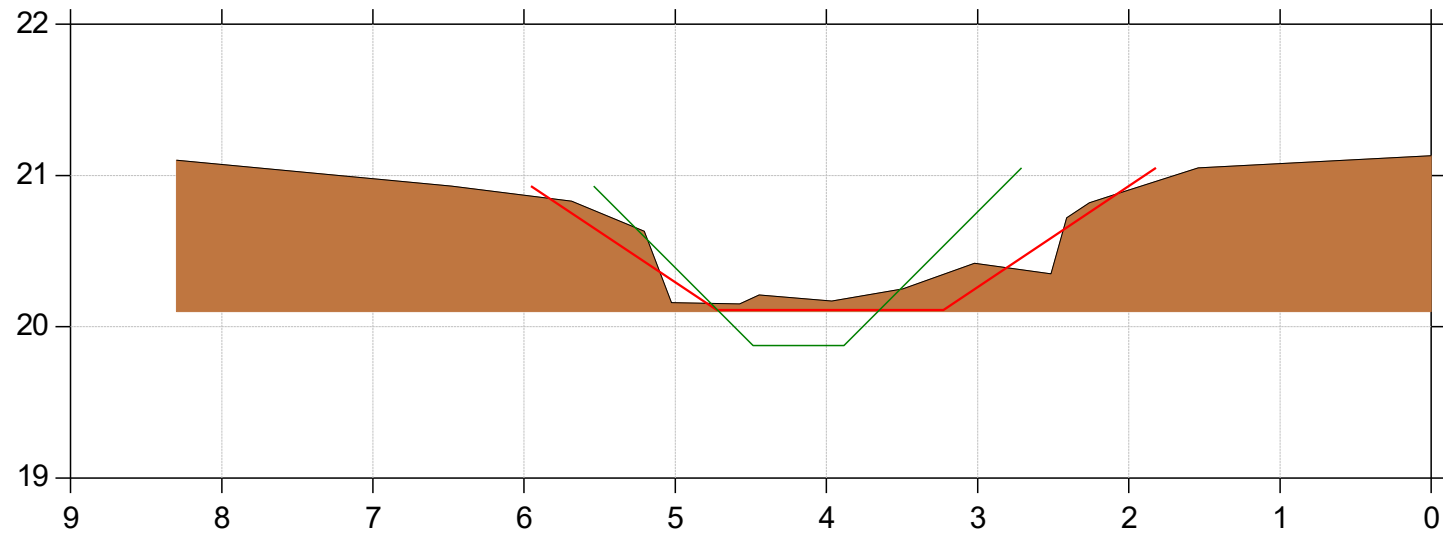

St. 4756

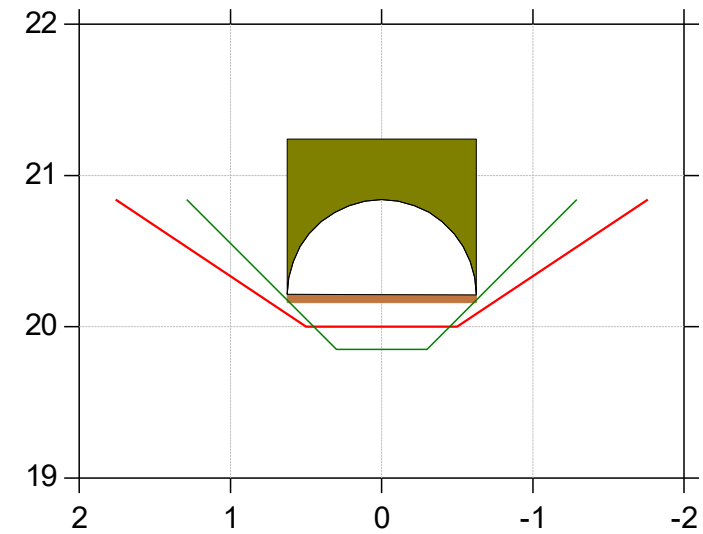

Almstrup Bæk

Regulativrevision

Lodret akse : Kote i m DVR90, skala 1:50

Vandret akse : Afstand i m, skala 1:50

- Tidligere regulativ
- Regulativ 2025
- Bund opmålt (2020/2024)

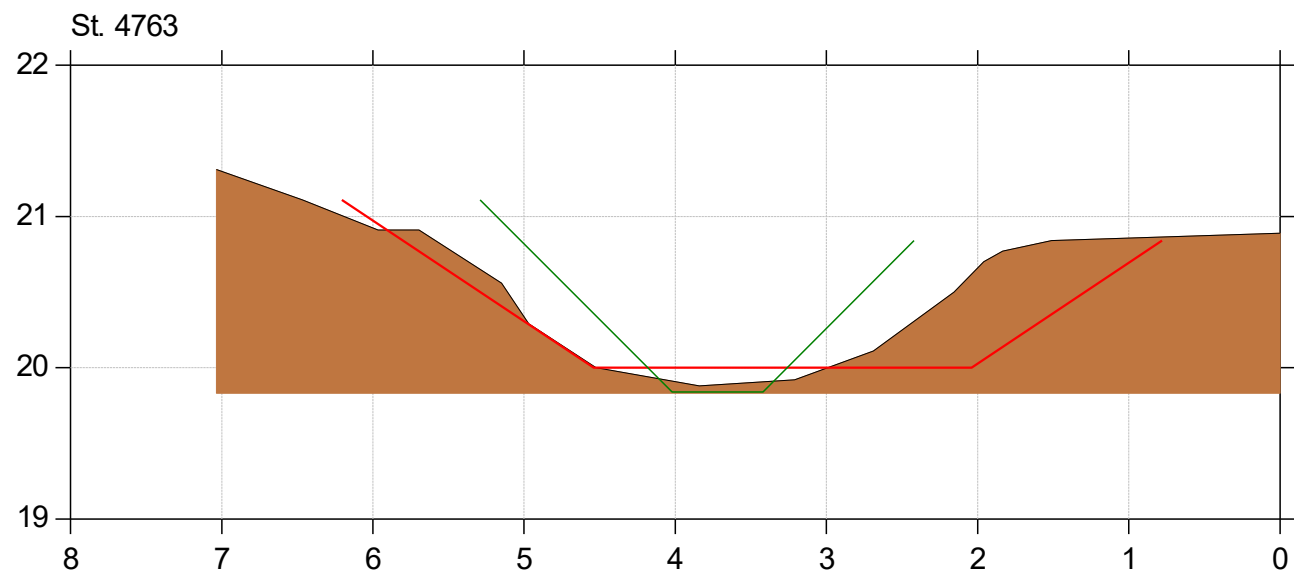
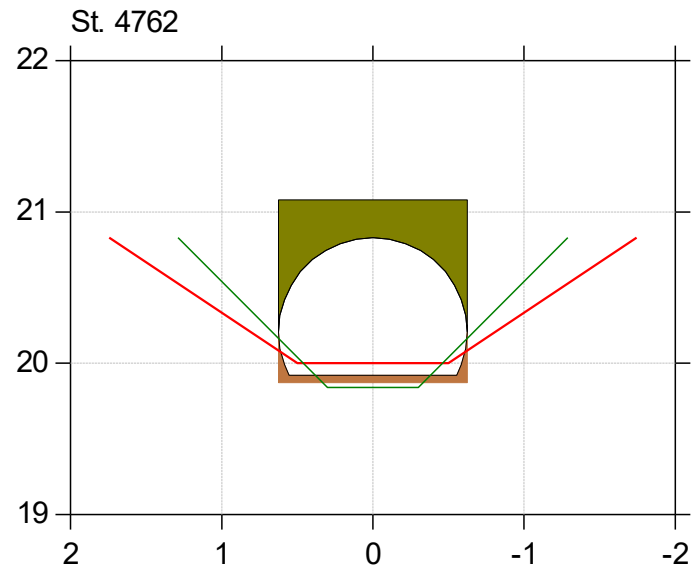

Almstrup Bæk

Regulativrevision

Lodret akse : Kote i m DVR90, skala 1:50

Vandret akse : Afstand i m, skala 1:50

- Tidligere regulativ
- Regulativ 2025
- Bund opmålt (2020/2024)

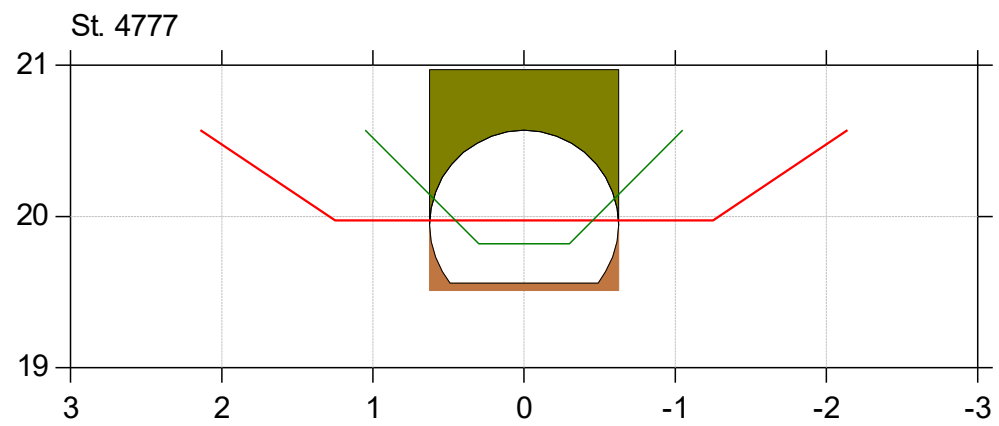
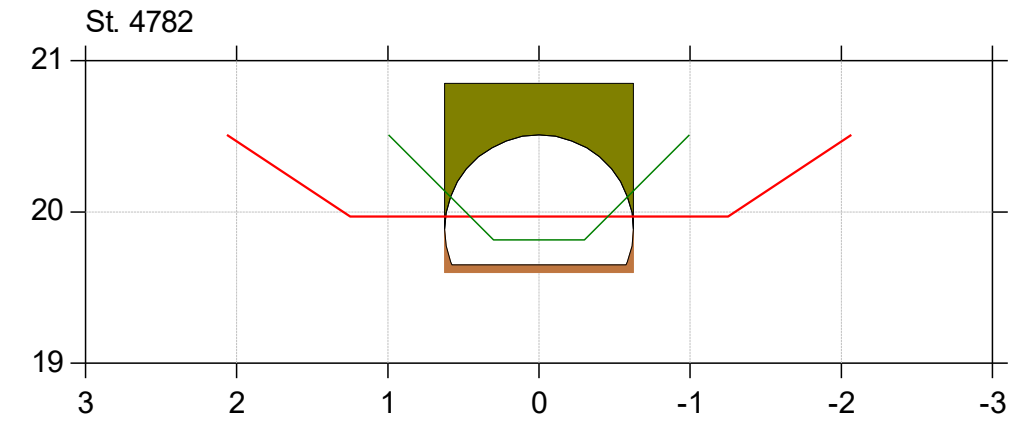
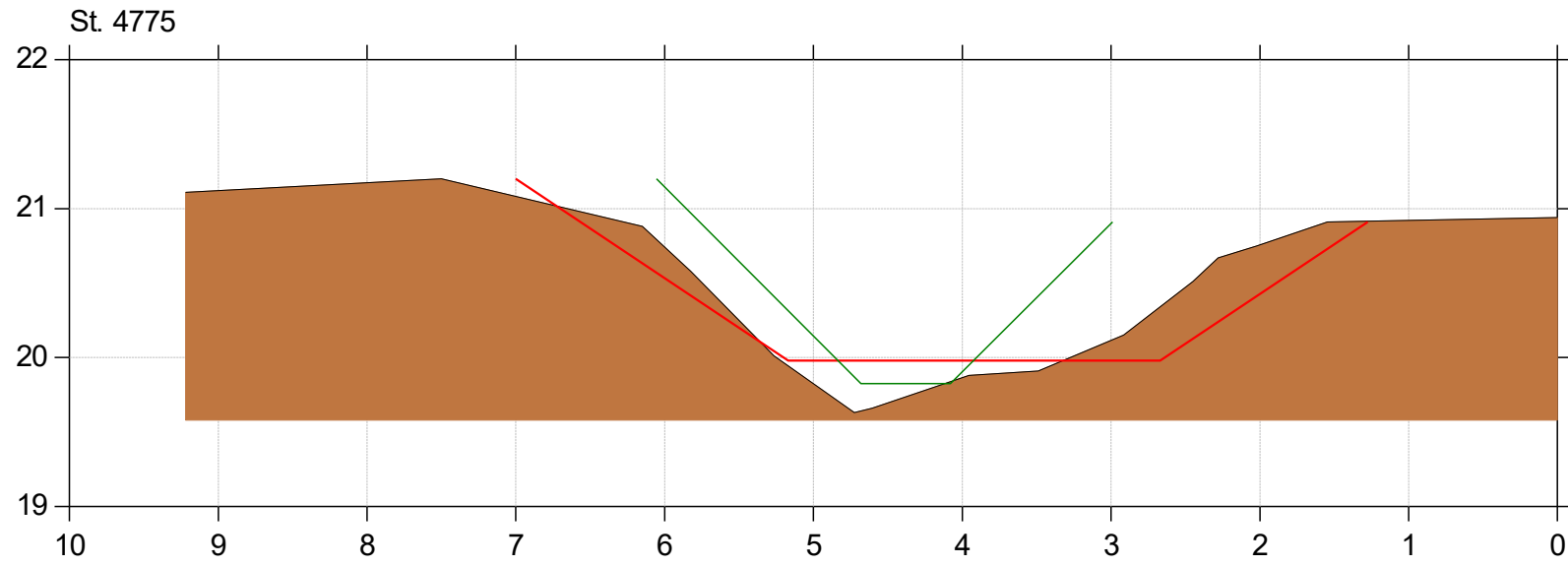

Almstrup Bæk

Regulativrevision

Lodret akse : Kote i m DVR90, skala 1:50

Vandret akse : Afstand i m, skala 1:50

- Tidligere regulativ
- Regulativ 2025
- Bund opmålt (2020/2024)

St. 4785

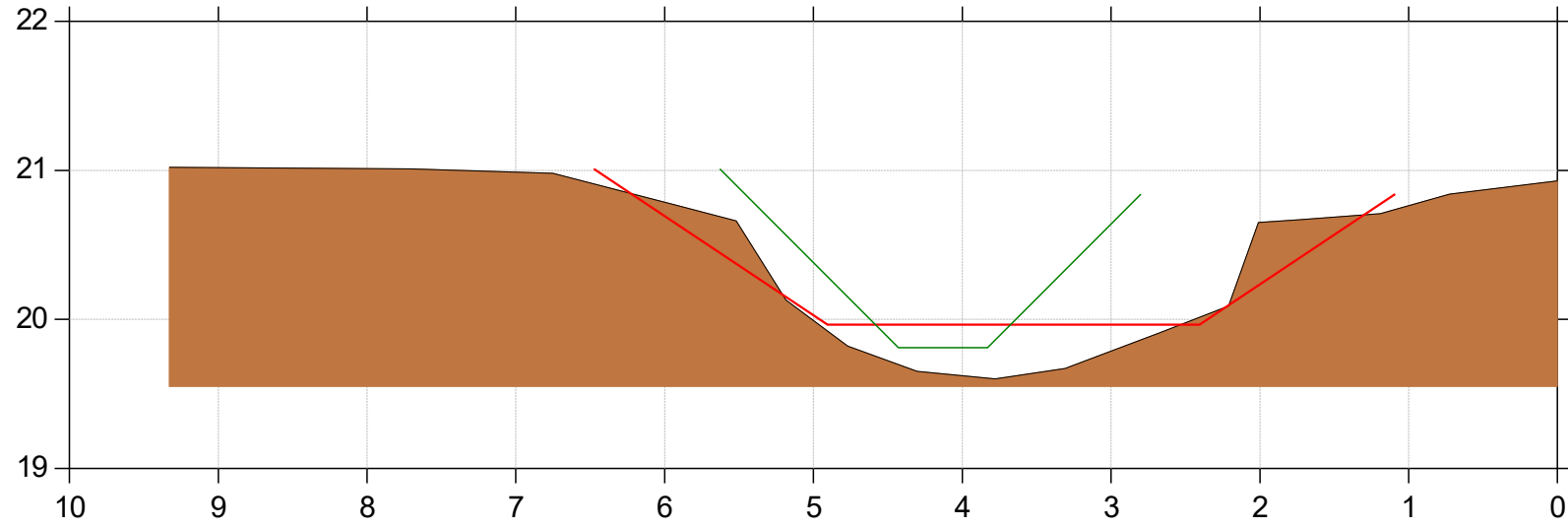

St. 4847

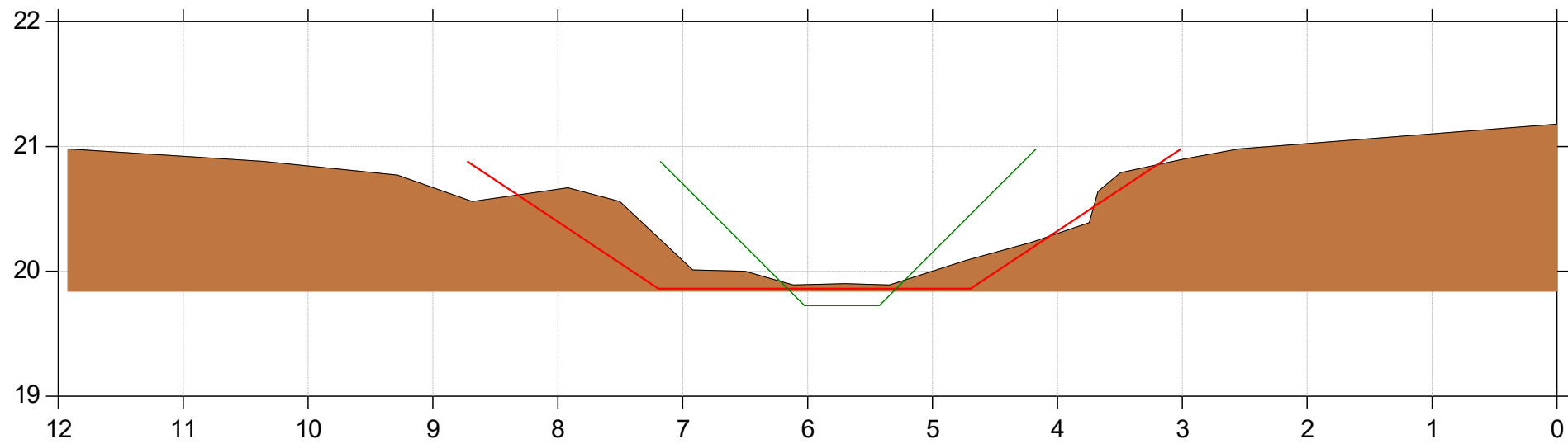

Almstrup Bæk

Regulativrevision

Lodret akse : Kote i m DVR90, skala 1:50

Vandret akse : Afstand i m, skala 1:50

- Tidligere regulativ
- Regulativ 2025
- Bund opmålt (2020/2024)

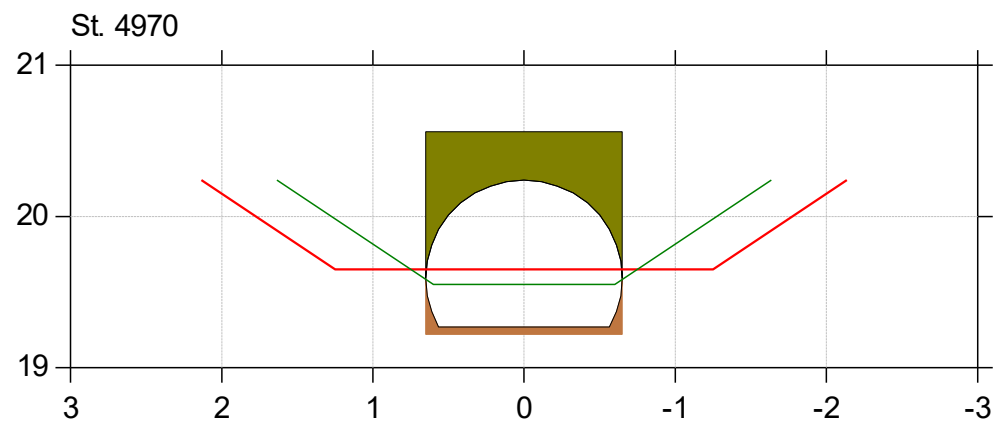
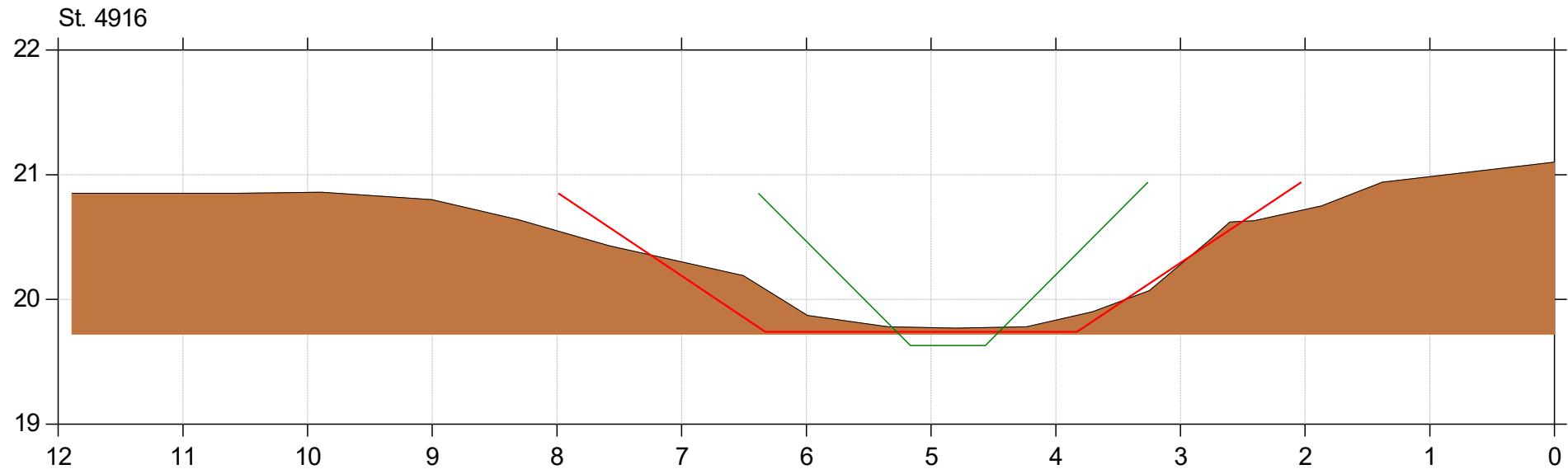

Almstrup Bæk

Regulativrevision

Lodret akse : Kote i m DVR90, skala 1:50

Vandret akse : Afstand i m, skala 1:50

- Tidligere regulativ
- Regulativ 2025
- Bund opmålt (2020/2024)

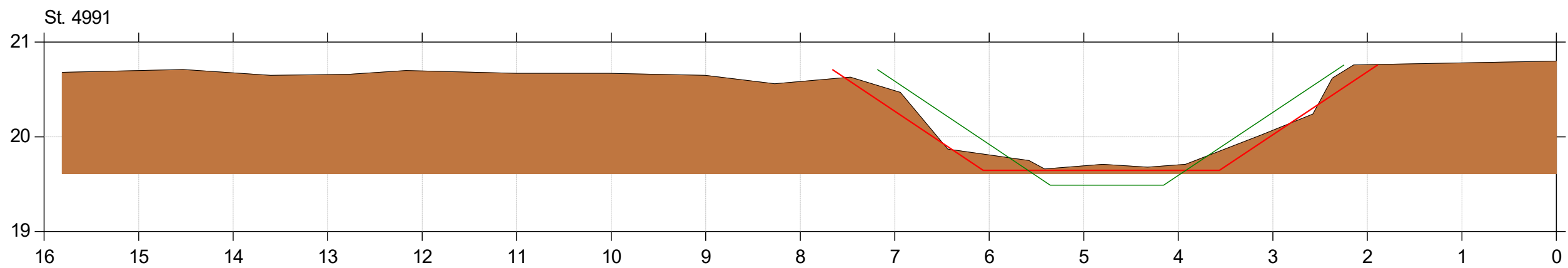
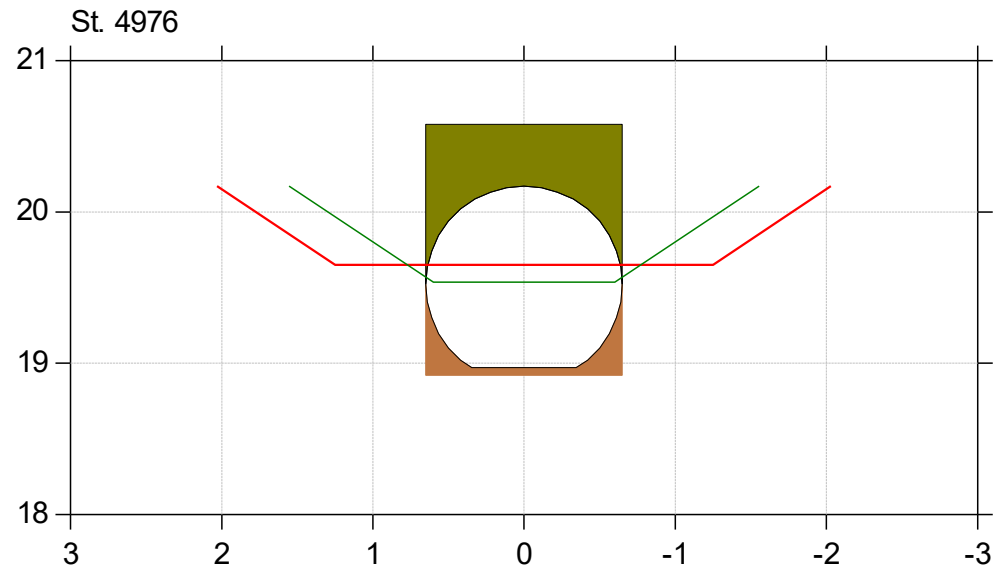

Almstrup Bæk

Regulativrevision

Lodret akse : Kote i m DVR90, skala 1:50

Vandret akse : Afstand i m, skala 1:50

- Tidligere regulativ
- Regulativ 2025
- Bund opmålt (2020/2024)

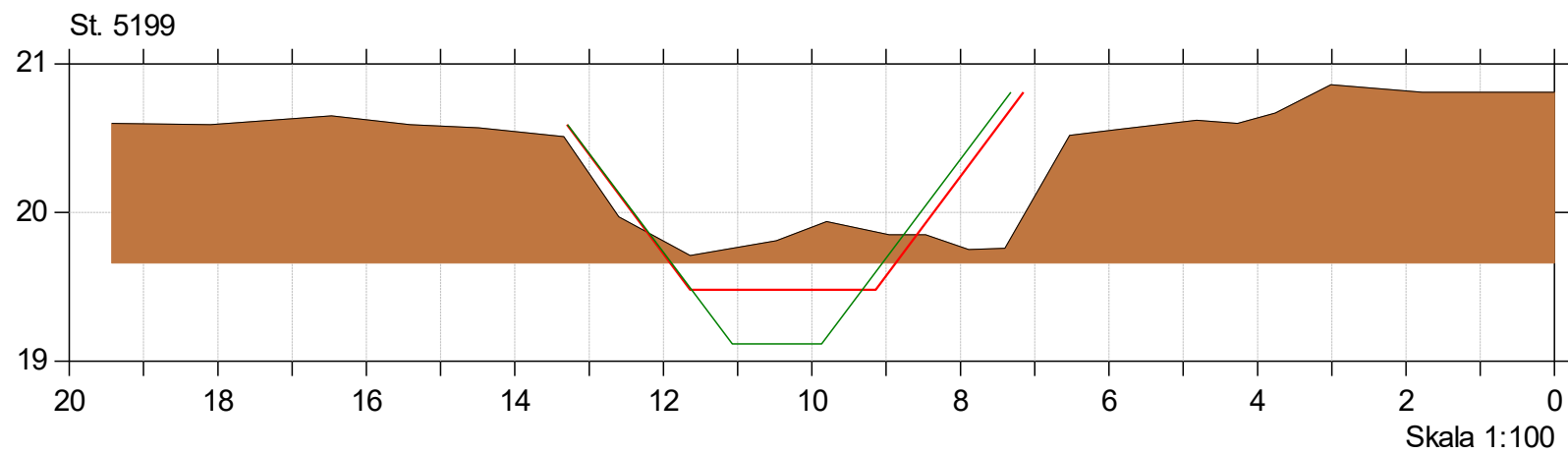
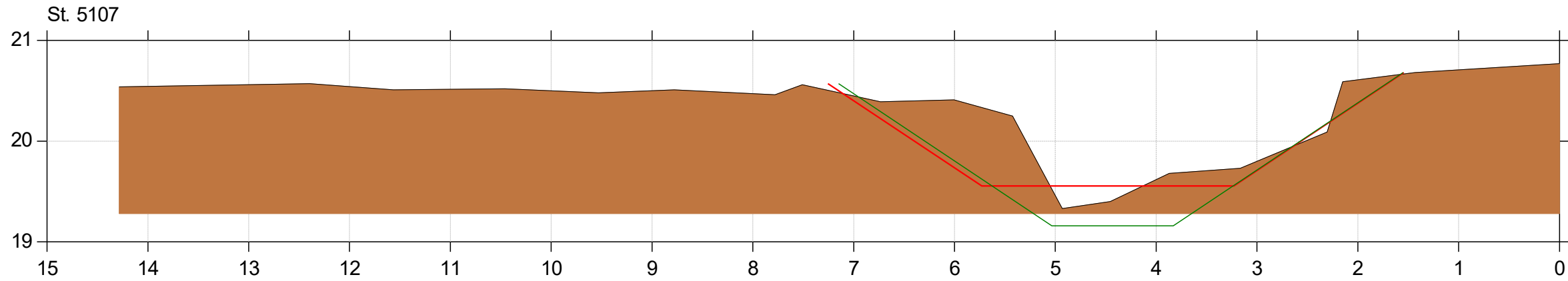

Almstrup Bæk

Regulativrevision

Lodret akse : Kote i m DVR90, skala 1:50

Vandret akse : Afstand i m, skala 1:50

- Tidligere regulativ
- Regulativ 2025
- Bund opmålt (2020/2024)

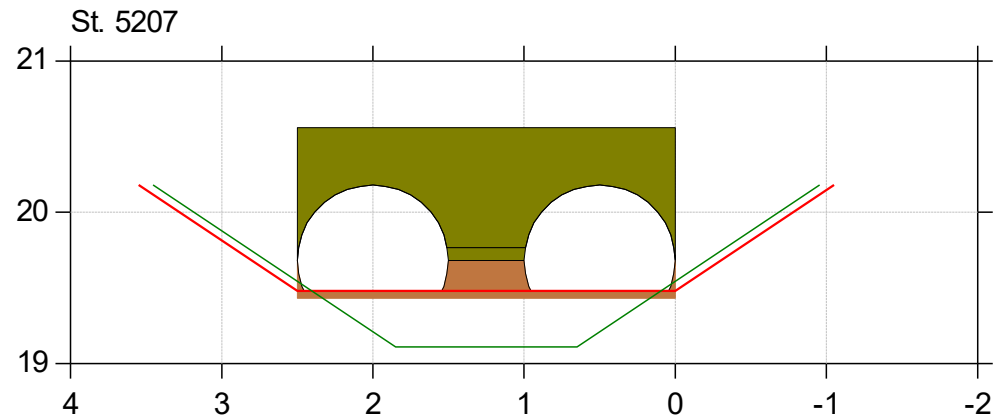
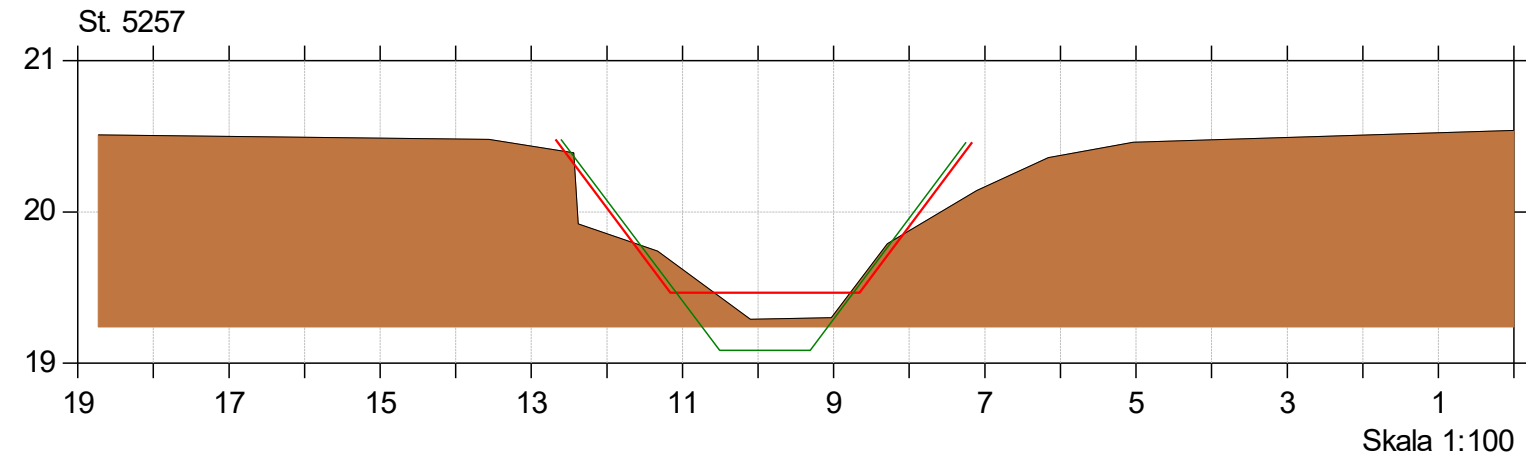
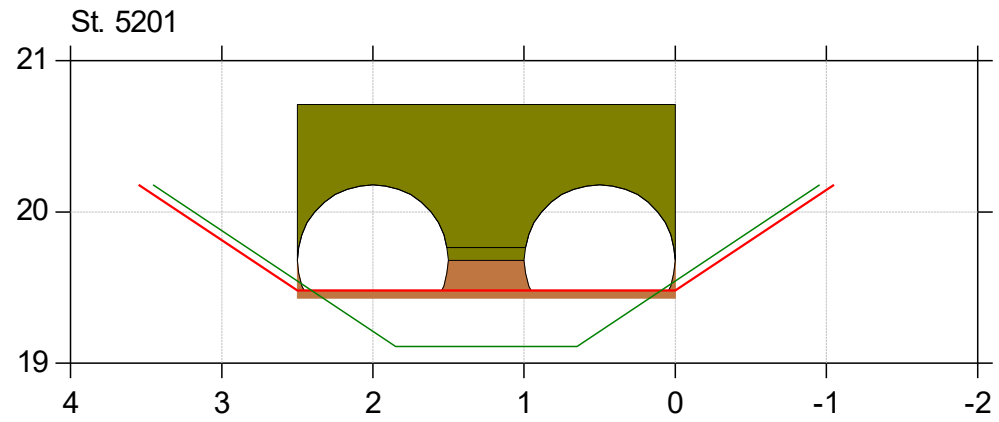

Almstrup Bæk

Regulativrevision

Lodret akse : Kote i m DVR90, skala 1:50

Vandret akse : Afstand i m, skala 1:50

- Tidligere regulativ
- Regulativ 2025
- Bund opmålt (2020/2024)

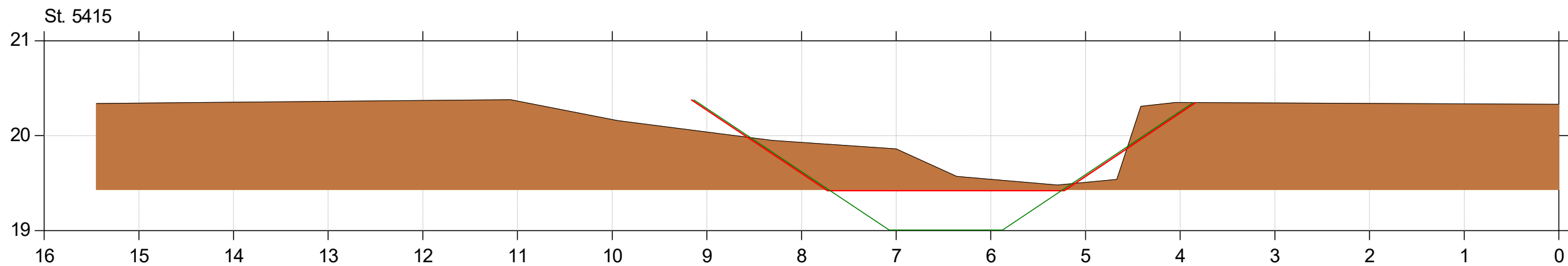
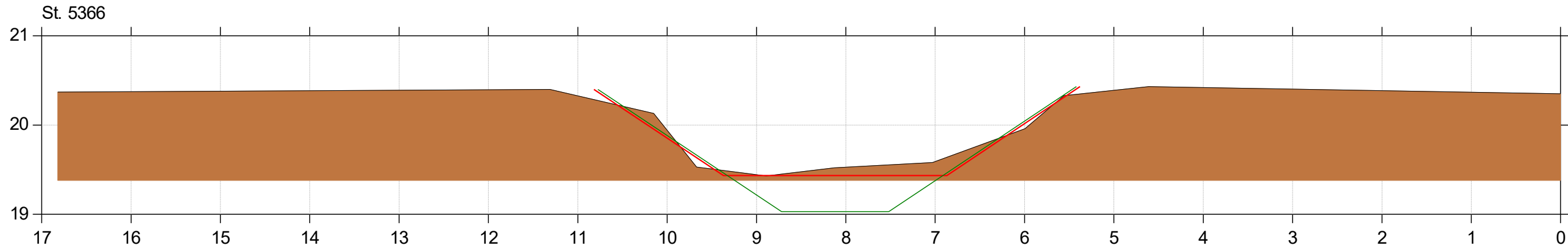

Almstrup Bæk

Regulativrevision

Lodret akse : Kote i m DVR90, skala 1:50

Vandret akse : Afstand i m, skala 1:50

- Tidligere regulativ
- Regulativ 2025
- Bund opmålt (2020/2024)

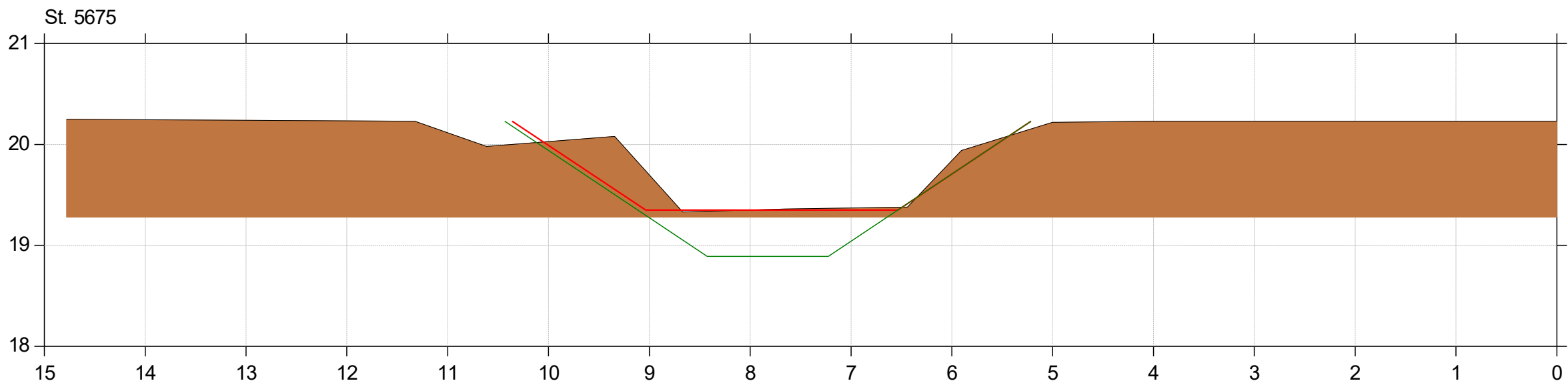
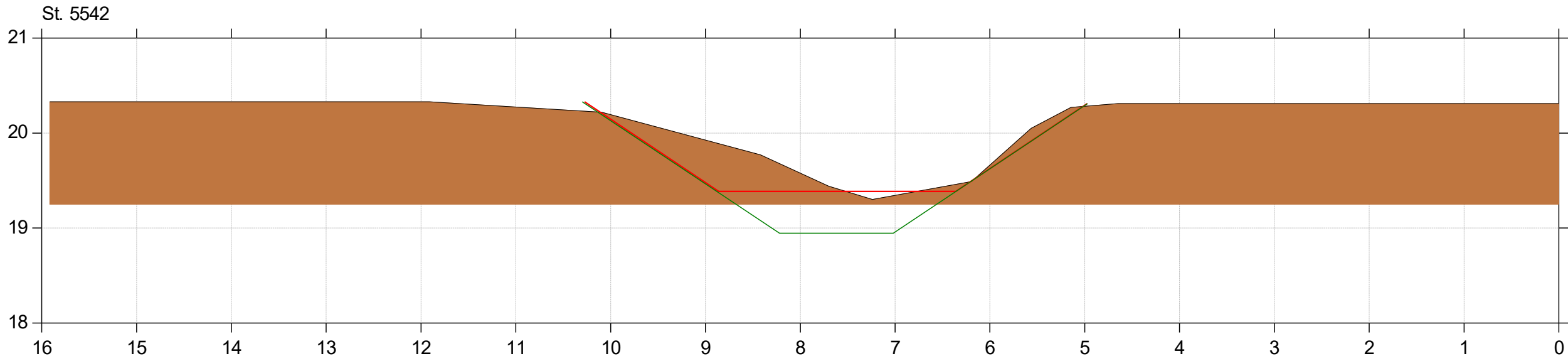

Almstrup Bæk

Regulativrevision

Lodret akse : Kote i m DVR90, skala 1:50

Vandret akse : Afstand i m, skala 1:50

- Tidligere regulativ
- Regulativ 2025
- Bund opmålt (2020/2024)

St. 5725

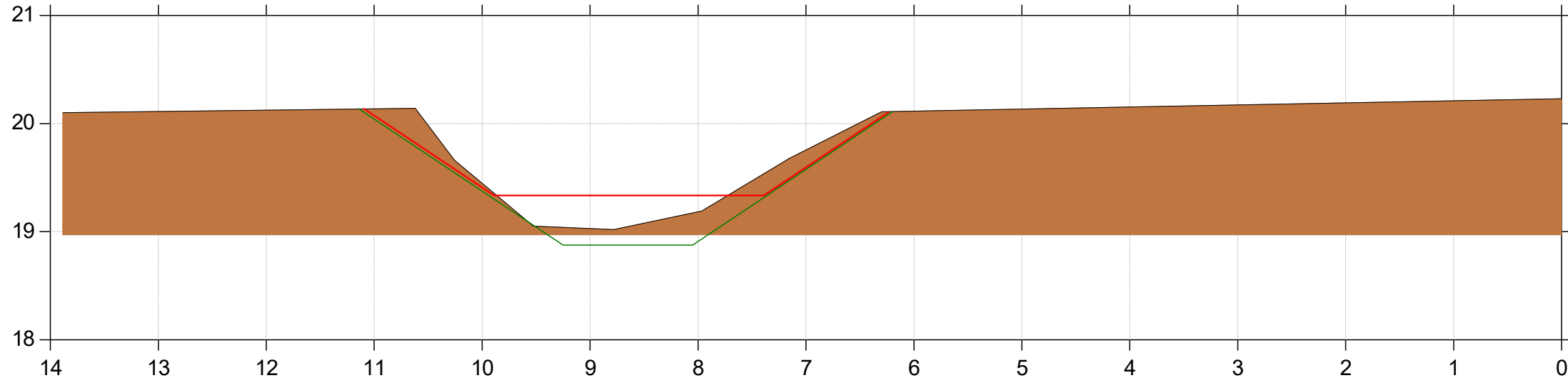

St. 5873

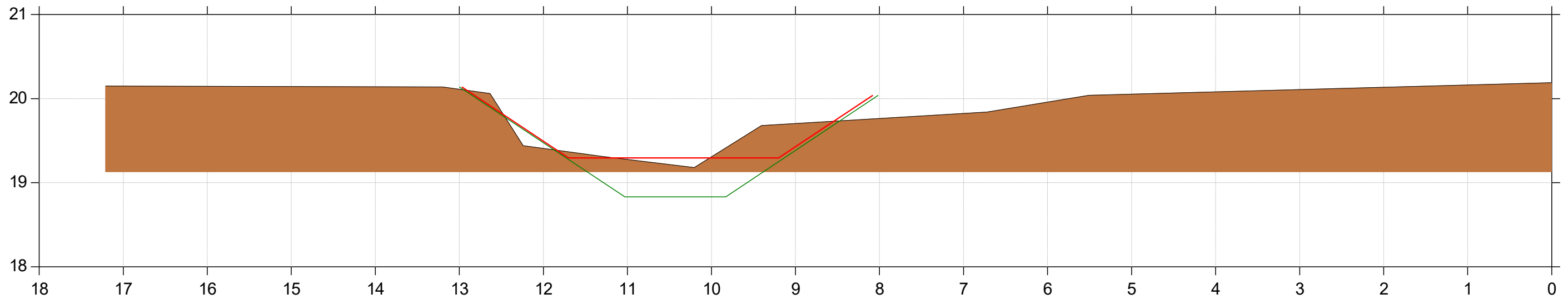

Almstrup Bæk

Regulativrevision

Lodret akse : Kote i m DVR90, skala 1:50

Vandret akse : Afstand i m, skala 1:50

- Tidligere regulativ
- Regulativ 2025
- Bund opmålt (2020/2024)

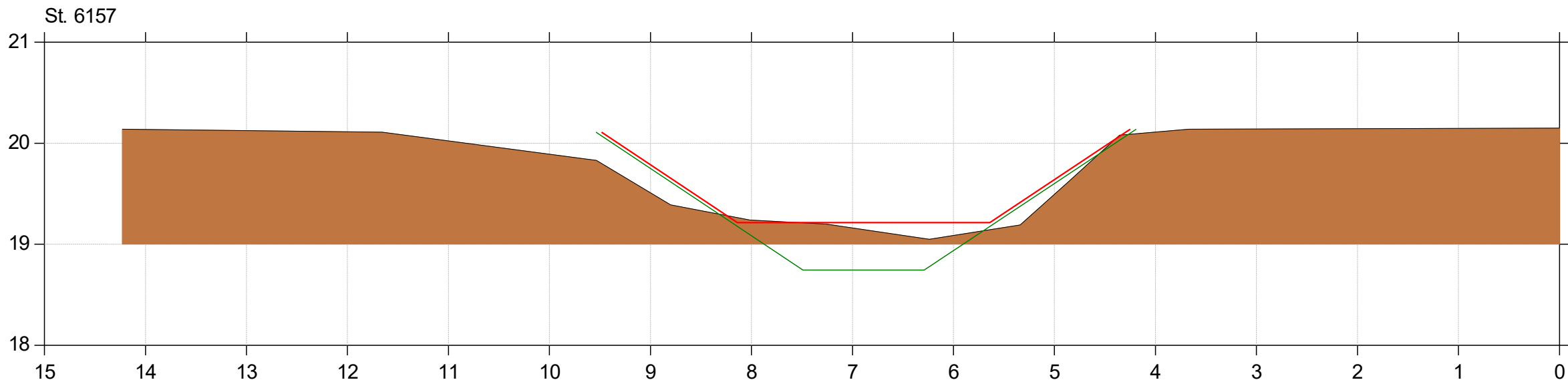
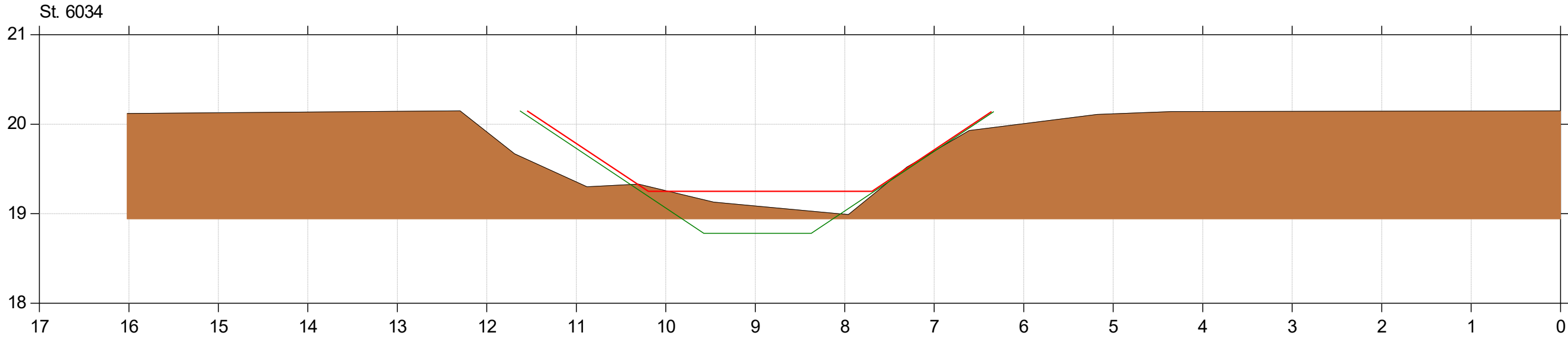



Almstrup Bæk

Regulativrevision

Lodret akse : Kote i m DVR90, skala 1:50

Vandret akse : Afstand i m, skala 1:50

-  Tidligere regulativ
-  Regulativ 2025
-  Bund opmålt (2020/2024)

St. 6284

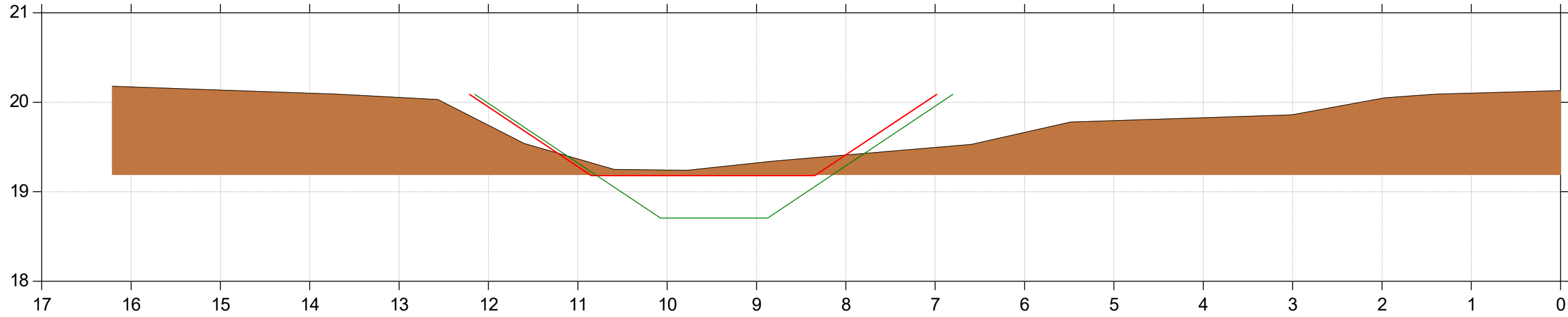

St. 6501

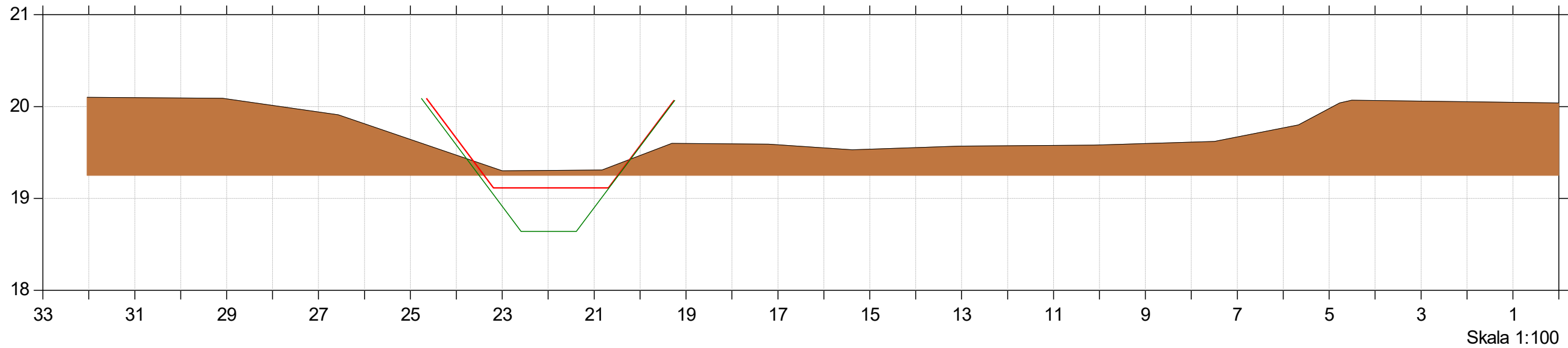

Almstrup Bæk

Regulativrevision

Lodret akse : Kote i m DVR90, skala 1:50

Vandret akse : Afstand i m, skala 1:50

- Tidligere regulativ
- Regulativ 2025
- Bund opmålt (2020/2024)

St. 6627

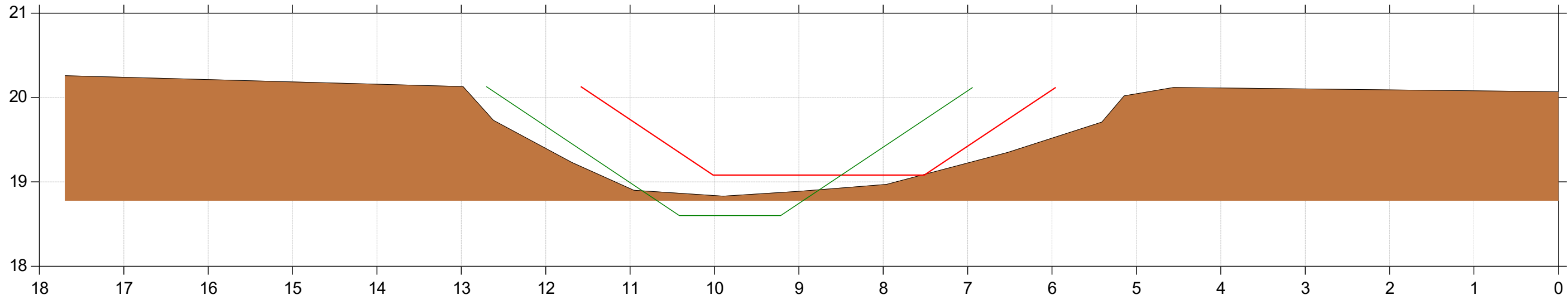

St. 6634

